

■
GLASS ACCESSORIES

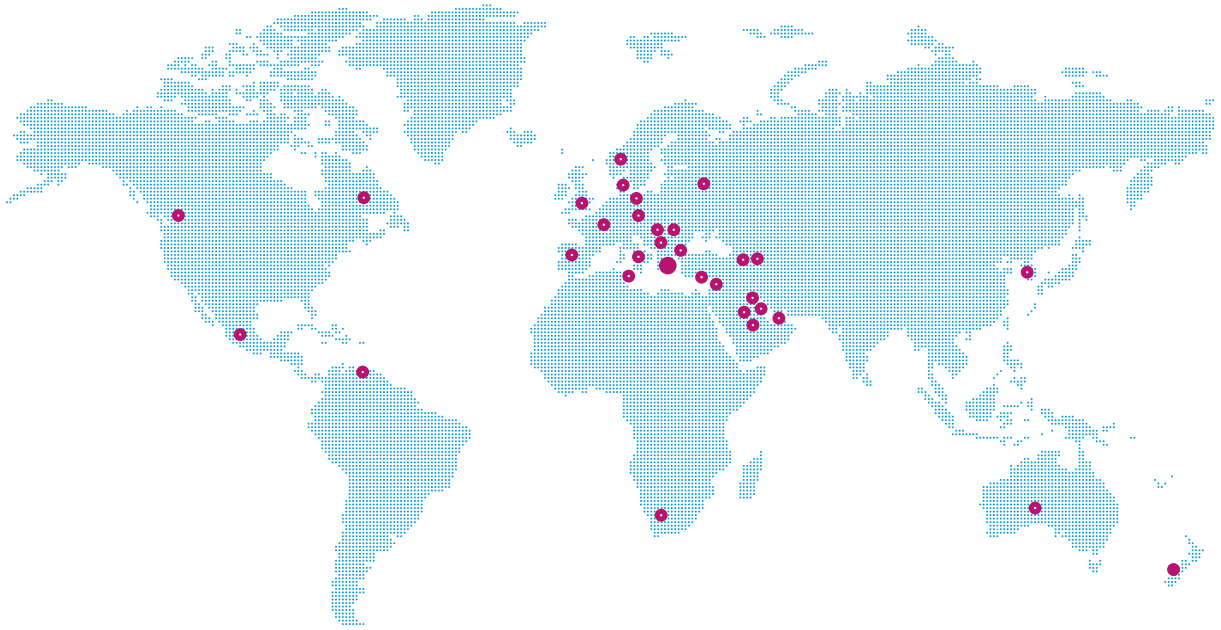



INTERMETAL S.A. established in 1990, is a modern, innovative industry specialising in designing & producing accessories and systems for architectural glass.

Its two industrial factories, operated at its headquarters in Koropi, Athens, covering an area of 12.000m² manufacture a wide range of high quality products under the brand names INAL[®] and NOSCAVO[®], providing solutions to architectural glass constructions.

As your partners in Glass Applications, we provide you with the following systems & accessories:

- The Patented Innovative Hydraulic Hinge glass door Closer NOSCAVO[®].
- Systems for Folding and Parking [Stacking] movable glass walls, components for internal glass Partitions and movable soundproof Partition walls.
- Sliding, Swing and Revolving manually or electrically operated glass doors systems and door Control applications.
- Systems and Components for glass Balustrades, such as rail profiles, glass clamps, handrails, clips etc.
- Glass door Accessories such as hinges, locks, handles and components for shower cabin applications.
- Stainless steel Accessories [PLANISPHERE[®] & MINOX[®]] for glass Facades, Canopies & Balustrades.
- Custom designed Metal accessories for glass applications.

The company applies a management system in Designing, Producing and Sales Building Industrial Equipment, Metallic Accessories and Systems for Glass Doors and Glass Panels. It has been certified with ISO 9001:2015 by TÜV NORD CERT and INAL[®] products comply with the regulations and certifications.

how to order

0000.000.00

PRODUCT NUMBER.DIMENSION.FINISHING

Dimensions are used for a limited range of products, such as handles. Wherever there is no dimension the product number is followed by the finishing code.

finishing

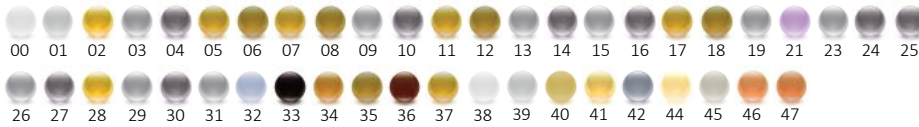

ALUMINUM

- 00 ALUMINUM MILLFINISH
- 01 NATURAL ANODISED
- 02 GOLD ANODISED
- 03 MIRROR CHROMED
- 04 SATIN CHROMED
- 05 GOLD MIRROR CHROMED
- 06 GOLD SATIN CHROMED
- 21 POWDER COATED, RAL
- 25 SATIN ANODIZED
- 33 BLACK ANODIZED
- 36 BRAUN ANODIZED
- 39 NATURAL POLISHED ANODIZED
- 40 ANTIQUE
- 42 GLOSSY ANODIZED ELECTROPOLISHED
- 44 CHAMPAGNE ANODIZED
- 45 ANODIZED UPON REQUEST

STAINLESS STEEL

- 37 GOLD PLATED
- 46 COPPER POLISHED
- 47 COPPER SATIN

Solid

- 13 POLISHED
- 14 SATIN

Casted

- 23 POLISHED
- 24 SATIN
- 40 ANTIQUE
- 41 ORO MAT

BRASS

Solid

- 07 POLISHED
- 08 SATIN
- 09 MIRROR CHROMED
- 10 SATIN CHROMED
- 11 GOLD MIRROR CHROMED
- 12 GOLD SATIN CHROMED
- 34 POWDER COATED, RAL

Casted

- 29 MIRROR CHROMED
 - 30 SATIN CHROMED
 - 35 GOLD CHROMED
- ### ZINC ALLOY [ZAMAK]
- 15 MIRROR CHROMED
 - 16 SATIN CHROMED
 - 17 GOLD MIRROR CHROMED
 - 18 GOLD SATIN CHROMED
 - 19 NICKEL

IRON

- 38 MILL FINISH
- 26 NICKEL POLISHED
- 27 NICKEL MAT
- 28 NICKEL GOLD
- 31 GALVANIZED
- 32 POWDER COATED, RAL

symbols

 GLASS THICKNESS  PRODUCT WEIGHT

VL 155C Chameleon
page 29



index

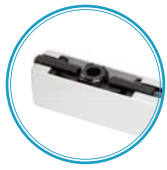

hinges

101	102, 102G	103	141	142	117	118	104, 114	144, 134	105 [ALUM.]
pg.14	pg.14	pg.14	pg.15	pg.15	pg.15	pg.15	pg.16	pg.16	pg.16
105G	105L	154	155	2100	2105	PR200-24	122	183	123
pg.16	pg.16	pg.17	pg.17	pg.17	pg.17	pg.17	pg.18	pg.18	pg.18
181 Brass	181 ZincAlloy	187	182	182 ZincAlloy	184	185	189	190	192
pg.18	pg.18	pg.19	pg.19	pg.19	pg.19	pg.20	pg.20	pg.20	pg.20
175	175.15LP	176	177.15LP	170	170.BB	170.30.BB	170V.BB	171	171S
pg.21	pg.21	pg.21	pg.21	pg.22	pg.22	pg.22	pg.22	pg.23	pg.23
179	173	173V	W100	152HD	152				
pg.23	pg.23	pg.24	pg.24	pg.24	pg.24				



locks

201 AL.	202 AL.	201 ST. STEEL	202 ST. STEEL	206	207	208	210	211	212
pg.26	pg.26	pg.26	pg.26	pg.27	pg.27	pg.27	pg.27	pg.28	pg.28



locks

230  pg.28	231  pg.28	VL 155 C  pg.29	247  pg.29	248  pg.29	247G  pg.30	243G  pg.30	244  pg.30	243  pg.30	280WC  pg.31
280  pg.31	281  pg.31	284  pg.31	285  pg.32	227  pg.32	228  pg.32	250  pg.32	252  pg.33	GAUDI FIT IN  pg.33	273  pg.33
275  pg.33	254  pg.34	256  pg.34	270  pg.34	272  pg.34	109  pg.35	111  pg.35	113  pg.35	2101  pg.35	2102  pg.35
2103  pg.35	2106  pg.35	261  pg.36	262  pg.36	263  pg.36	264  pg.36	265  pg.36	266  pg.36	267  pg.36	268  pg.36



bolts

900  pg.38	901  pg.38	910  pg.38	910C  pg.38	903G  pg.39	903  pg.39	904  pg.39	908  pg.39	909  pg.40	911  pg.40
912  pg.40	911.SQ  pg.40								



electric locks

1581	290	934	924	295	297	298	9334VGL	294E	296E
pg.42	pg.42	pg.42	pg.42	pg.42	pg.42	pg.42	pg.42	pg.43	pg.43
258	259	299E	1700	291A	291B	291C	292	293	
pg.43	pg.43	pg.43	pg.43	pg.43	pg.43	pg.43	pg.43	pg.43	

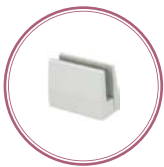

clips

401	402	403 ST. STEEL	405	406	407	408	414	415	416
pg.46	pg.46	pg.46	pg.47	pg.47	pg.47	pg.47	pg.48	pg.48	pg.48
461	463	464	471	472	474	1620.414045.14	412	413	410 Z. ALLOY
pg.48	pg.49	pg.49	pg.49	pg.49	pg.50	pg.50	pg.50	pg.50	pg.51
411 Z. ALLOY	410 ST. STEEL	411 ST. STEEL	850 AL.	850 ST. STEEL					
pg.51	pg.51	pg.51	pg.52	pg.52					



support & spacers

									
801	809	802	803	806	821	810	811	812	804
pg.54	pg.54	pg.54	pg.54	pg.54	pg.54	pg.54	pg.54	pg.54	pg.55
									
890	816	817	818	818LP.08	819	819LP.08	826	827	828
pg.55	pg.55	pg.55	pg.55	pg.55	pg.55	pg.55	pg.56	pg.56	pg.56
									
831	832	880	881	1656	310-08/32	882	883	884.40/50	885.45
pg.56	pg.56	pg.56	pg.56	pg.56	pg.56	pg.57	pg.57	pg.57	pg.57

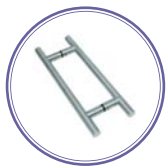

handles

									
601	602	605	606	624	609	610	619	604.40	604.50
pg.60	pg.60	pg.60	pg.60	pg.60	pg.60	pg.60	pg.60	pg.60	pg.60
									
604.75	627.38	623.30	628.30	622.30	629.32	629.50	612.40	612.50	613.40
pg.60	pg.61	pg.61	pg.61	pg.61	pg.61	pg.61	pg.61	pg.61	pg.61
									
614.25	615.22								
pg.61	pg.61								

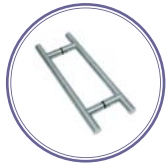

handles

640



| pg.62

640.18



| pg.62

631



| pg.62

644



| pg.62

646



| pg.62

644.2545.13



| pg.62

651.45/28.13



| pg.63

651.45/25.13



| pg.63

643.2550.13



| pg.63

642



| pg.63

643



| pg.63



proofing

752



| pg.65

751



| pg.65

703



| pg.65

701



| pg.65

1400/1440



| pg.65

1401



| pg.65

1403



| pg.65

1404/1402



| pg.65

1413/1423



| pg.65

1408



| pg.65

1409



| pg.65

1405/1445



| pg.65

1412/1443



| pg.66

1415/1441



| pg.66

1421



| pg.66

1422



| pg.66

1422



| pg.66

1435



| pg.66

1442/1438/1436



| pg.66

1444.2010.10



| pg.66

1446.10.30



| pg.66

1406.10.30



| pg.66



bracket- pivot

1003



pg.68

1004



pg.68

1005 1006

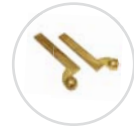

pg.68

1007



pg.68

FRP75-17



pg.68

FN200-17



pg.68

PR100-17



pg.68

PR200-17



pg.68

1130



pg.69

1130.HD



pg.69

1120



pg.69

1230



pg.69

1230.HD



pg.69

1220



pg.69



cylinders

2200



pg.70

2201



pg.70

2202



pg.70

2203



pg.70

2204



pg.70

2209.19



pg.70



shower supports

1709



pg.72

1713.S



pg.72

1714.S

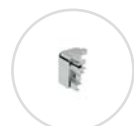

pg.72

1711



pg.72

1710



pg.72

1713.B

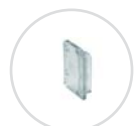

pg.72

1714.B



pg.72

1712



pg.72

1715



pg.72

197



pg.73

198



pg.73

199



pg.73

1692 S.STEEL



pg.73

1692 AL.



pg.73

ANGF1001.13



pg.74

341.160.13



pg.74



floor springs

NS100H.13



pg.76

2000



pg.76

2022



pg.76

2020



pg.76

2028



pg.76

2071.13



pg.76

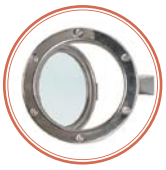

various

1300



pg.78

1302



pg.78

1505



pg.78

1627



pg.78

1729



pg.78

1733



pg.78

1738



pg.78

DECO



pg.78





hinges

HINGES

101

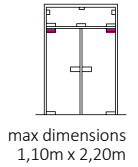
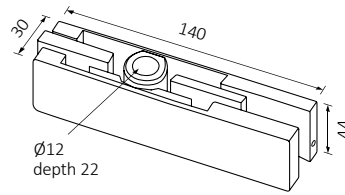

Upper hinge

10mm 339 gr

Cover finishing .01 .02 .07 .08 .13 .14 .21 .25

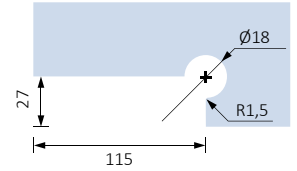

102

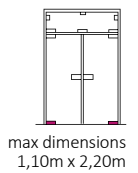
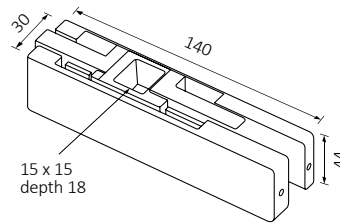

Lower hinge

10mm 328 gr

Cover finishing .01 .02 .07 .08 .13 .14 .21 .25

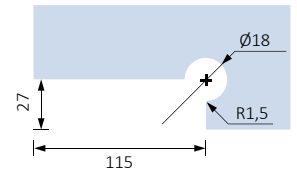

102G.01

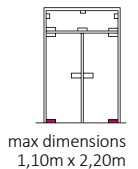
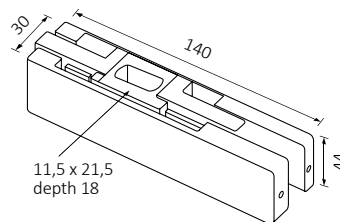

Lower hinge for flat cone spindle

10mm 328 gr

Cover finishing .01 .02 .07 .08 .13 .14 .21 .25

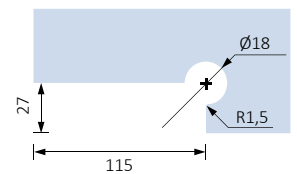

103

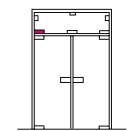
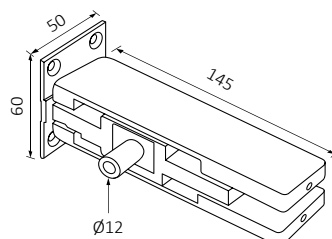

Wall Glass Support with pivot

10mm, 353 gr

Cover finishing .01 .02 .07 .08 .13 .14 .21 .25

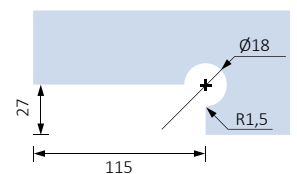

141

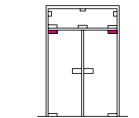
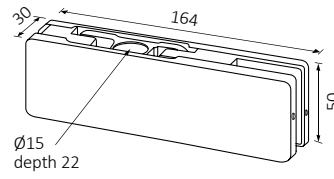

max dimensions
1,10m x 2,50m

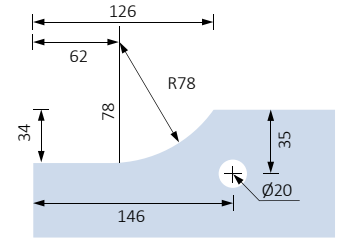

Upper hinge

10- 12mm 558 gr | Cover finishing .13 .14

142

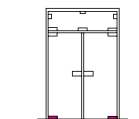
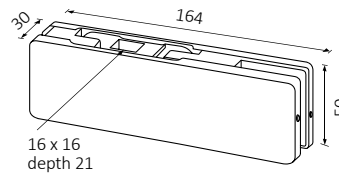
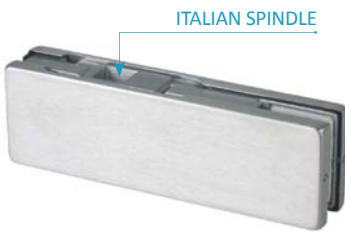

max dimensions
1,10m x 2,50m

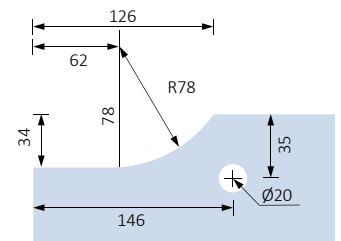

Lower hinge

10-12mm 618 gr | Cover finishing .13 .14

117

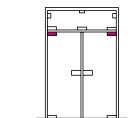
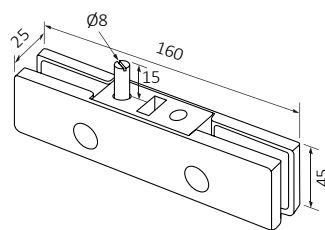

max dimensions
1,10m x 2,20m

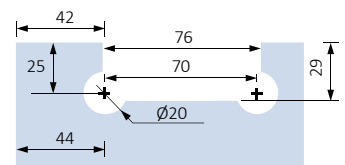

Upper hinge S.G.

10mm 672 gr | Finishing .19

118

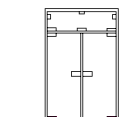
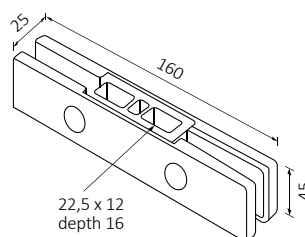
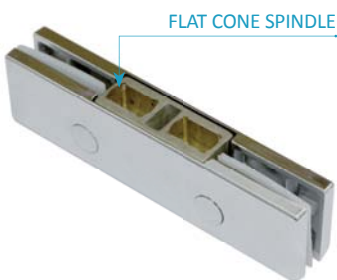

max dimensions
1,m x 2,20m

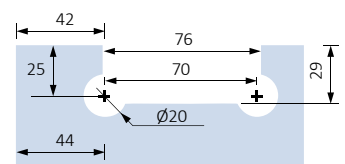

Lower hinge S.G.

10mm 613 gr | Finishing .19

Dimensions mm

HINGES

104 [RIGHT]

114 [LEFT]

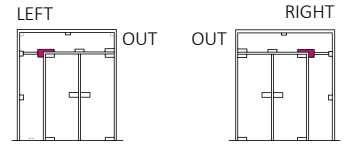
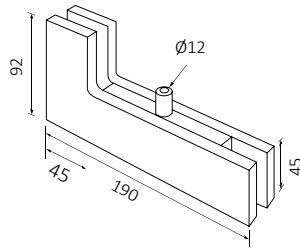

Angle Pivot Support Left/Right

● 10/20mm* ● 709 gr | Finishing .13 .14

SUITABLE FOR HINGE 101

* For 20mm Glass, upon request

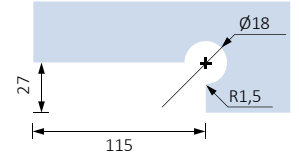

134 [RIGHT]

144 [LEFT]

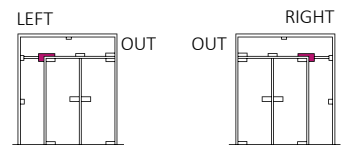
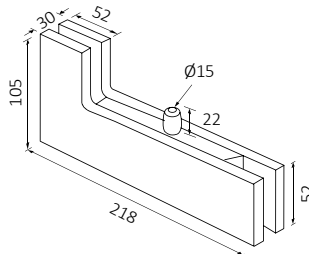

Angle Pivot Support Left/ Right

● 10mm ● 2188 gr | Finishing .13 .14

SUITABLE FOR HINGE 141

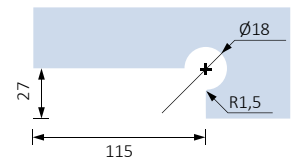

top pivot for hinges

105 [ALUMINUM]



SUITABLE FOR HINGE 101

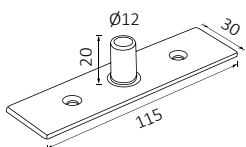

Rectangular top pivot

● 41 gr | Finishing .01 .02 .07 .08 .21 .25

105G [STAINLESS STEEL]



SUITABLE FOR HINGE 141

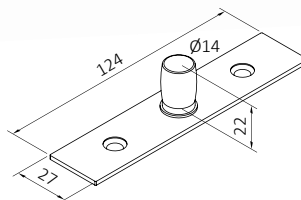

Rectangular top pivot

● 77 gr | Finishing .13 .14

105L [STAINLESS STEEL]



SUITABLE FOR SWING DOOR RAILS

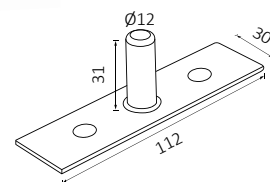

Rectangular top pivot LONG

● 88 gr | Finishing .13 .14

154

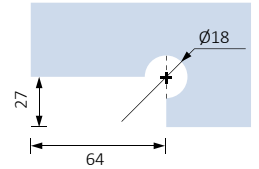
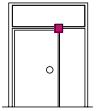
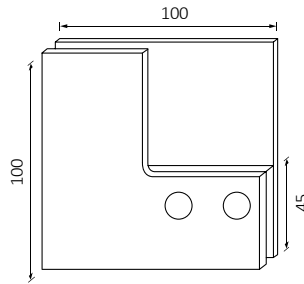

Angle Pivot Mini with Stop

10- 12mm 520 gr | Finishing .01 .02 .21 .25

155

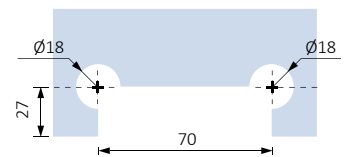
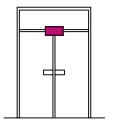
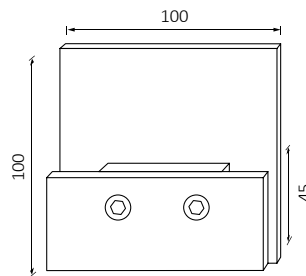

Double Swing Door Stopper

10-12mm, 450 gr | Finishing .01 .02 .21 .25

covers for hinges

2100

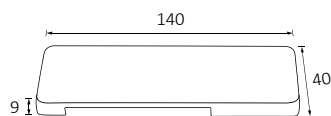

Hinge Cover [for 101- 102- 103]

20-60 gr | Finishing .01 .02 .07 .08 .13 .14 .21 .25

2105

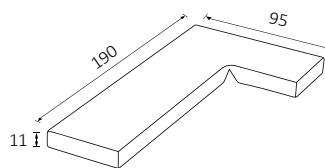

Angle Cover [for 104]

128 gr | Finishing .07 .08 .13 .14 .21 .25

floor busing

PR200-24

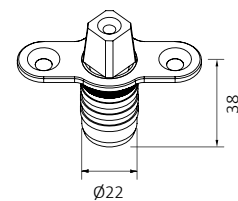

Floor Busing, Stainless Steel

152 gr

HINGES

122

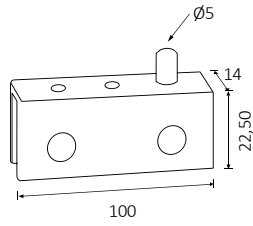

Hinge for 4-6 mm glass

4-6mm 40 gr | Finishing .09 .10 .11

183

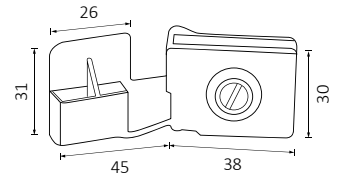

Additional hinge for 4-6 mm glass

4-6mm 70 gr | Finishing .09 .11

123

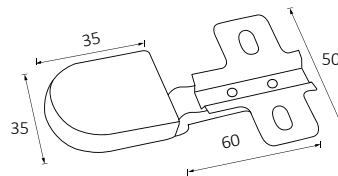

Glass hinge

4-6mm 60 gr | Finishing .09 .10 .11

123E

Full overlay mounting

123G

Half overlay mounting

123M

Inset mounting

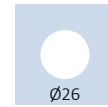

181 [BRASS]

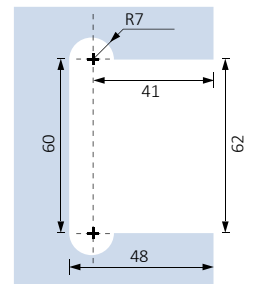
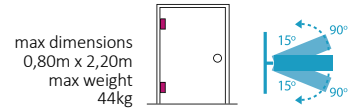
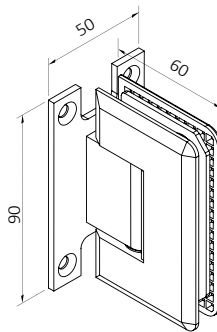

Hinge with Stop G-T

8-10mm, 473 gr | Finishing .09 .10 .11 .21 .29 .30

181 [ZINC ALLOY]

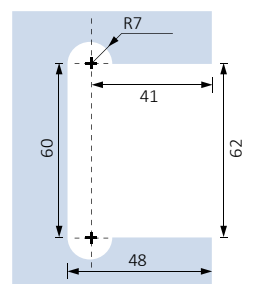
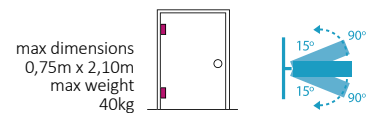
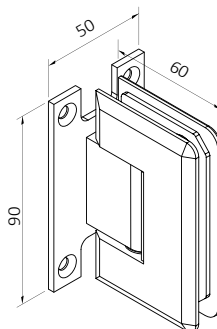

Hinge with Stop G-T

8-10mm, 473 gr | Finishing .15 .16

187

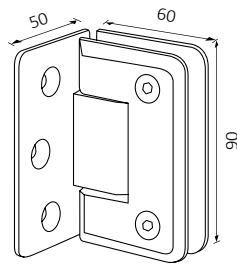

max dimensions
0,80m x 2,20m
max weight
44kg

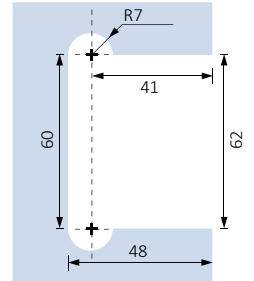
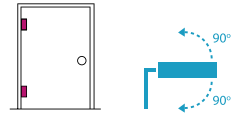

Hinge with Stop G-W [Side Plate]

8-10mm, 540 gr | Finishing .09 .10 .11 .21 .29 .30

182

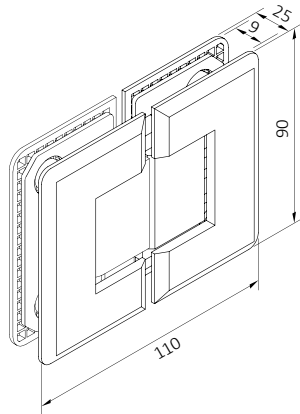

max dimensions
0,80m x 2,20m
max weight
44kg

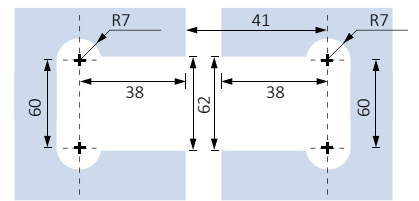
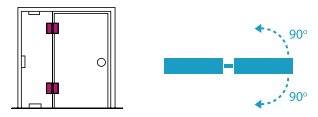

Hinge with Stop G-G

8-10mm, 773 gr | Finishing .09 .10 .11 .21 .29 .30

182 [ZINC ALLOY]

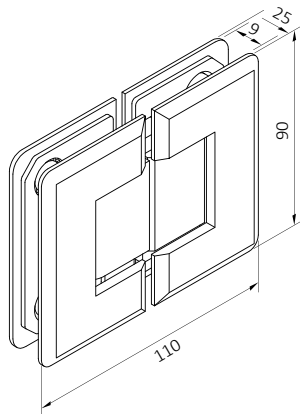

max dimensions
0,75m x 2,10m
max weight
40kg

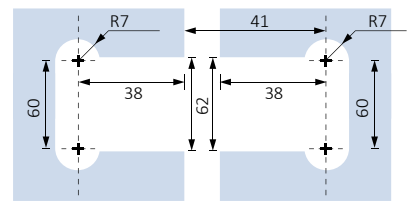

Hinge with Stop G-G

8-10mm, 773 gr | Finishing .15 .16

184

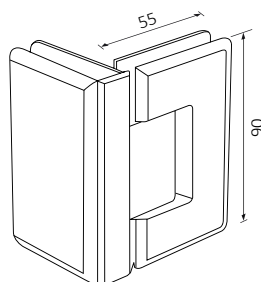

max dimensions
0,80m x 2,20m
max weight
44kg

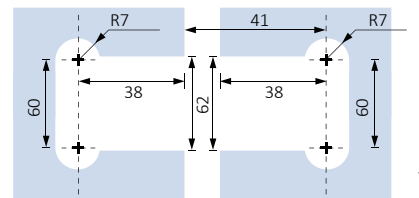
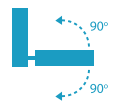

Hinge with Stop 90° G-G

8-10mm, 823 gr | Finishing .09 .21 .29 .30

Dimensions mm

HINGES

185



FIXED GLASS
SIDE EDGE 45°

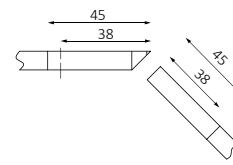
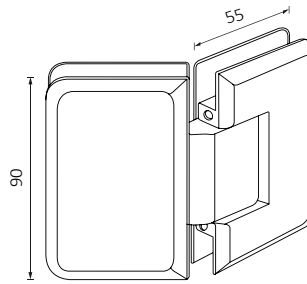

max dimensions
0,80m x 2,20m
max weight
44kg

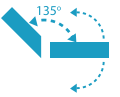

Hinge with Stop 135° G-G

8-10mm, 768 gr | Finishing .09 .21 .29
.30

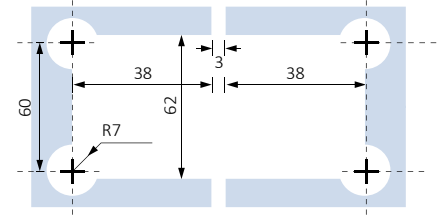

189

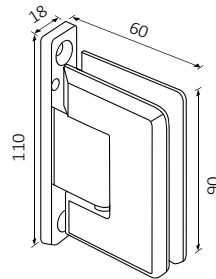

189.15
max dimensions 0,75m x 2,10m
max weight 40kg

189.29
max dimensions 0,80m x 2,10m
max weight 42kg

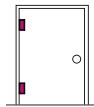

Hinge with Stop G-W

8-10mm, 458 gr | Finishing .15 .21 .29

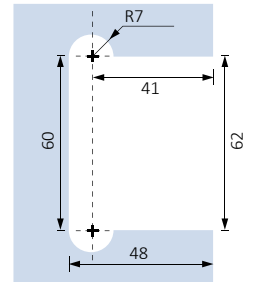

190

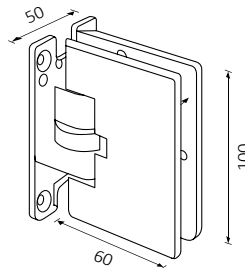

max dimensions
0,90m x 2,20m
max weight
50kg

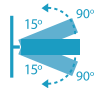

Hinge with Return G-W

8-10mm, AL. 490 gr | Finishing .01 .02 .09 .10 .21 .25

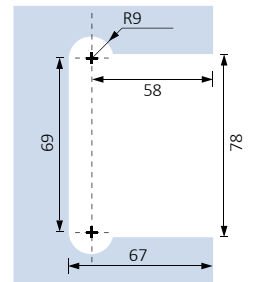

192

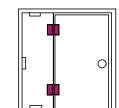
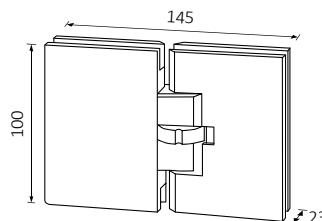

Hinge with Return G-G

8-10mm, 801 gr | Finishing .01 .02 .21 .25

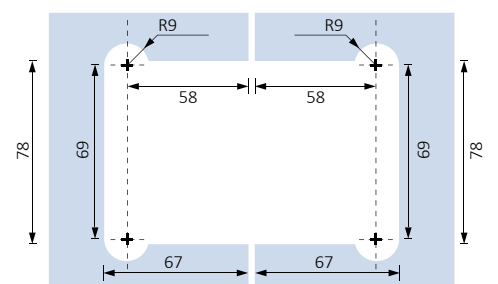

175

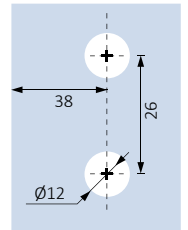
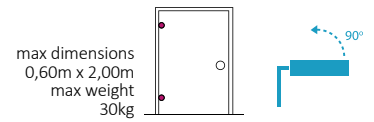
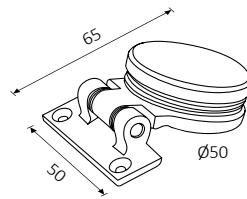

Bathroom Hinge G-W

6-8mm 97 gr | Finishing .15 .17

175.15LP

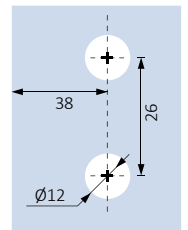
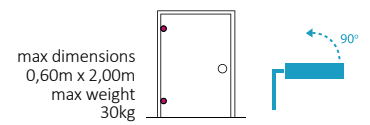
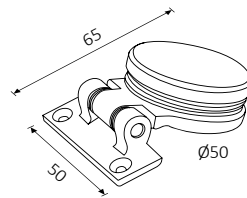

Bathroom Hinge G-W

6-8mm 210 gr | Finishing .15

176

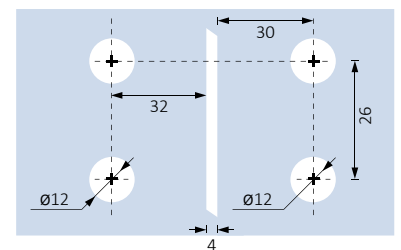
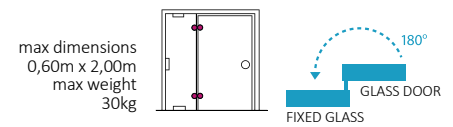
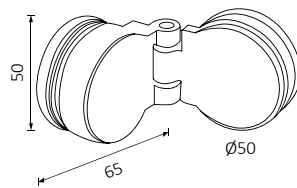

Bathroom Hinge G-G

6-8mm 209 gr | Finishing .15 .17

177.15LP

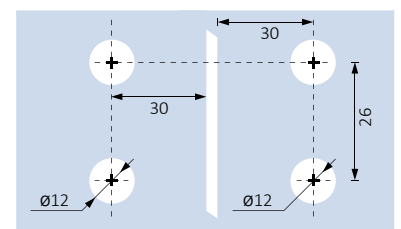
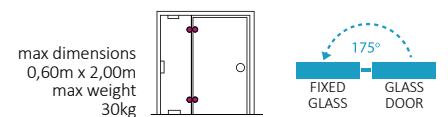
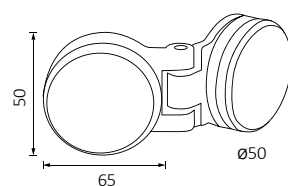

Bathroom Hinge G-G

6-8mm 304 gr | Finishing .15

Dimensions mm

HINGES

170

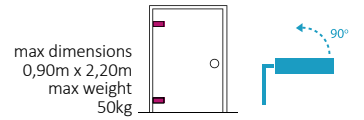
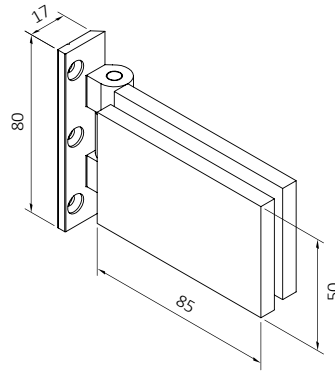

Hinge Glarit G-W

- Tempered 10-12mm [8mm upon request]
- 239 gr | Finishing .01 .02 .03 .15 .16 .21 .25

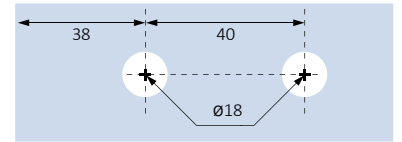

170.BB

SAFETY FIXING PLATE

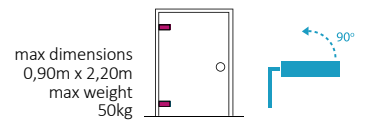
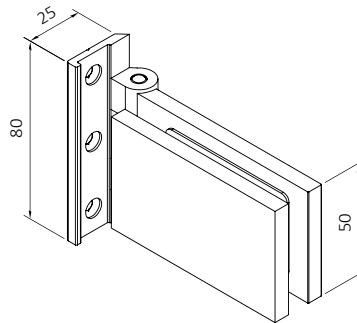

Hinge Glarit G-W Big Base

- Tempered 10-12mm [8mm upon request]
- 245 gr | Finishing .01 .21 .25

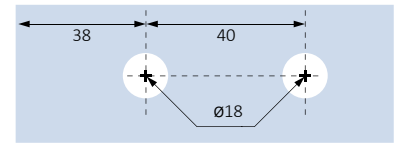

170.30.BB

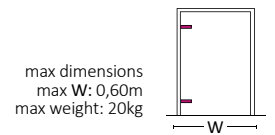
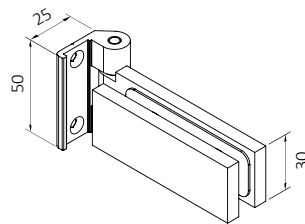

Hinge Glarit 30 mm G-W

- Tempered 8-10mm
- 160 gr | Finishing .01 .21 .25

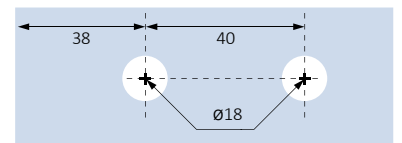

170V.BB

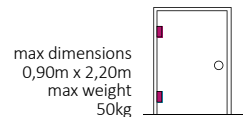
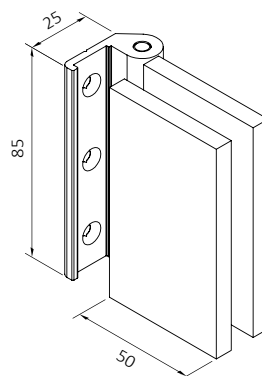

Vertical Hinge Glarit G-W Big Base

- Tempered 10-12mm [8mm upon request]
- 265 gr | Finishing .01 .21 .25

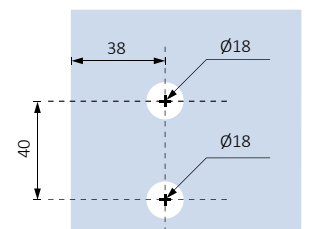

171

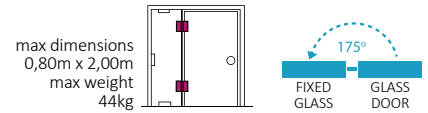
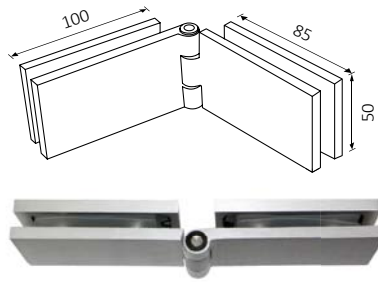

Hinge Glarit G-G

- Tempered 10-12mm [8mm upon request]
- 420 gr | Finishing .01 .02 .03 .15 .16 .21 .25

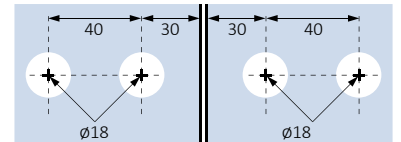

171.S

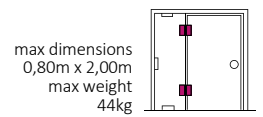
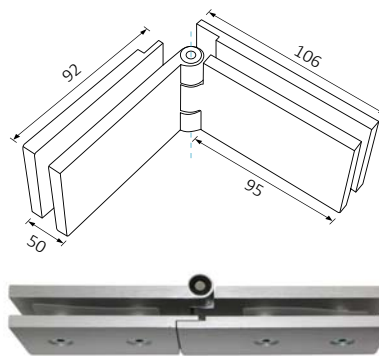
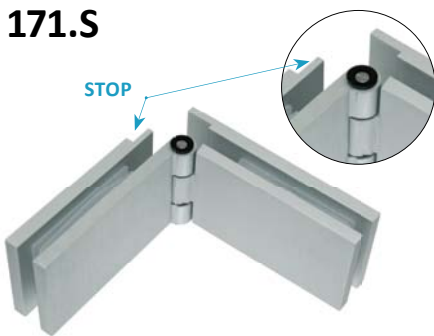

Hinge Glarit G-G with STOP

- Tempered 10-12mm [8mm upon request]
- 383 gr | Finishing .01 .02 .21 .25

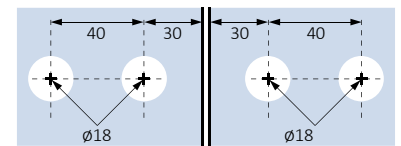

179

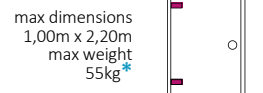
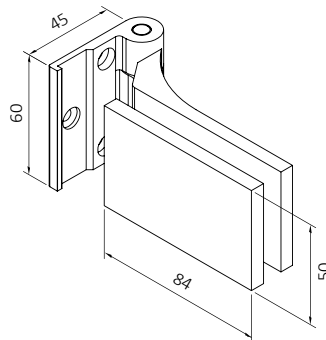

Hinge Glarit
LINE DESIGN

- Tempered 10-12mm
- 304 gr | Finishing .01 .02 .21 .25

Suitable for INAL door case series profile
Elegance

* The specification applies to the use of the product in INAL's Case

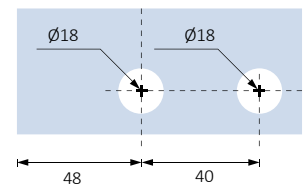

173

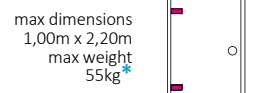
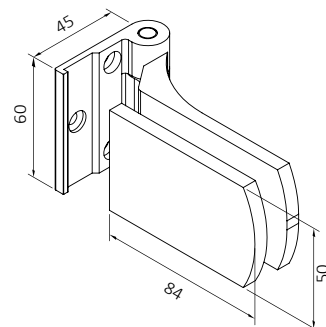

Hinge Glarit
CURVED DESIGN

- Tempered 10-12mm
- 301 gr | Finishing .01 .02 .21 .25

Suitable for INAL door case series profile
Elegance

* The specification applies to the use of the product in INAL's Case

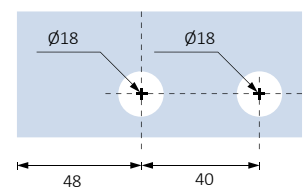

Dimensions mm

HINGES

173V

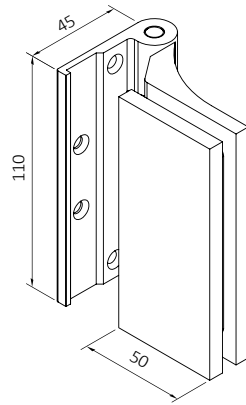

max dimensions
1,00m x 2,50m
max weight
65kg

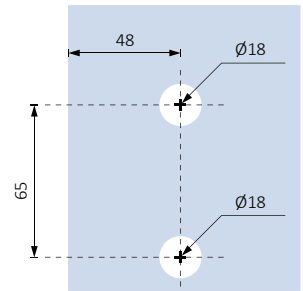
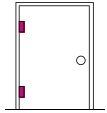

Vertical hinge Glarit G-W

Tempered 10-12mm 490 gr | Finishing .01 .21 .25

* The specification applies to the use of the product in INAL's Case

W100

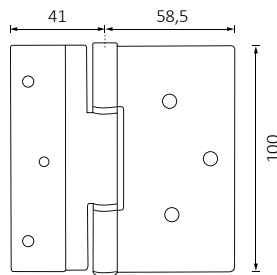

Hinge for Wooden Door

108 gr | Finishing .01 .02 .21 .25

Suitable for INAL door case profile
Elegance K100

152 HD

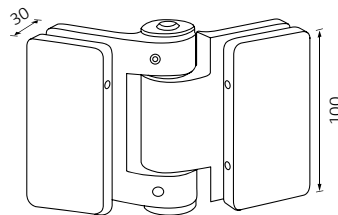

max dimensions
1,00m x 2,50m
max weight
125kg

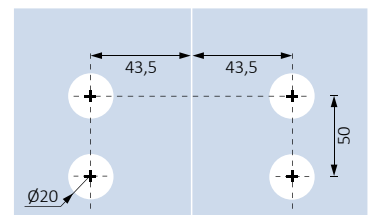
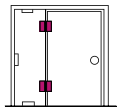

Heavy Duty Glass to Glass Hinge G-G

10-16mm, 1083 gr | Finishing .01 .02 .21 .25

152.SQ

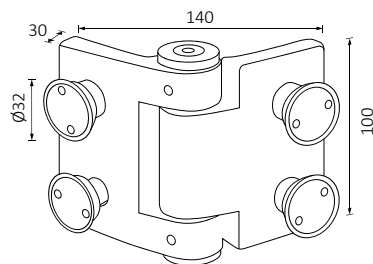

max dimensions
1,00m x 2,50m
max weight
125kg

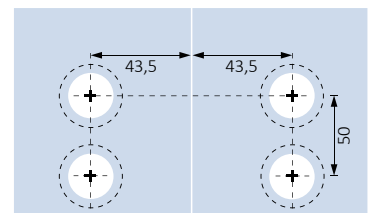
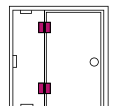

Squash Hinge G-G

10-16mm, 797 gr | Finishing .01 .02 .21 .25

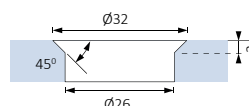

Dimensions mm



locks

LOCKS

201 [ALUMINUM]

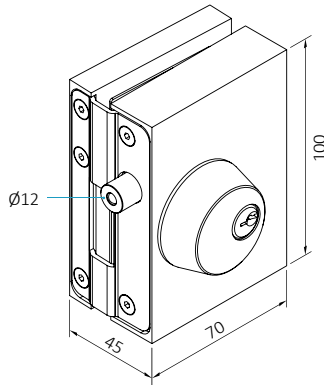

Additional Lock [Double Locking]

10-20mm 864 gr | Finishing .01 .02 .21

CODES 201 - 202

Type of Lock	Glass Thickness		
	10 -12 mm	14 -16 mm	18 -20 mm
Additional Lock	201	201.15	201.20
Female	202	202.15	202.20
Set Additional Lock with Female	200	200.15	200.20

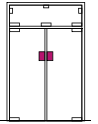

GLASS CUTTING NOT REQUIRED

AVAILABLE WITH
 • 2201 SECURITY CYLINDER
 • 2209 CYLINDER WITH KNOB

202 [ALUMINUM]

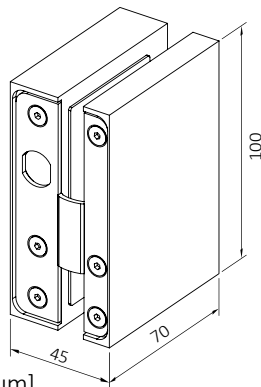

Additional Lock Female [for lock 201 aluminum]

10-20mm 677 gr | Finishing .01 .02 .21

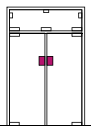

GLASS CUTTING NOT REQUIRED

201 [STAINLESS STEEL]

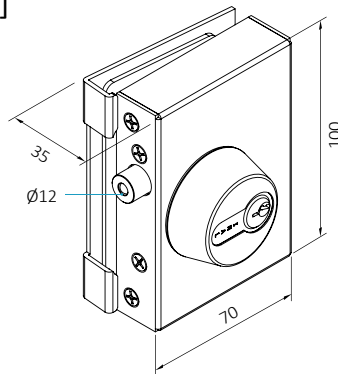

Additional Lock [Double Locking]

10-20mm 652 gr | Cover finishing .13 .14

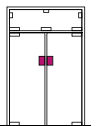

GLASS CUTTING NOT REQUIRED

AVAILABLE WITH
 • 2201 SECURITY CYLINDER
 • 2209 CYLINDER WITH KNOB

202 [STAINLESS STEEL]

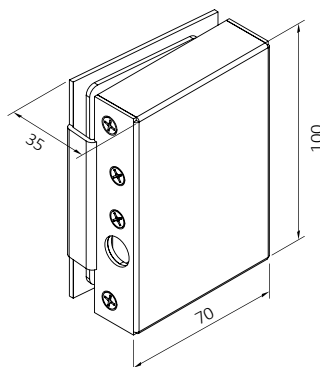

Additional Lock Female [for lock 201 Stainless Steel]

10-20mm 361 gr | Finishing .13 .14

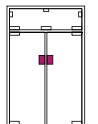

GLASS CUTTING NOT REQUIRED

206

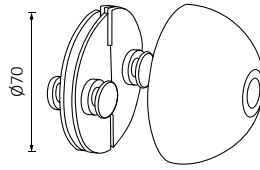

GLASS CUTTING NOT REQUIRED

Additional Lock Bull [SECURITY CYLINDER]

206 10mm 497 gr | Finishing .21 [RAL 9006]

206.15.21 15mm 497 gr | Finishing .21 [RAL 9006]

207



2207 CYLINDER WITH KNOB

AVAILABLE WITH 2201 SECURITY CYLINDER

CODE 207		
Type of Lock	Glass Thickness	
		15mm
Additional Double Lock	207.15	207.20

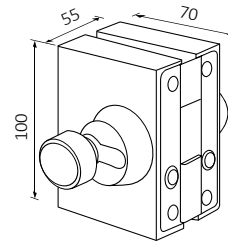

GLASS CUTTING NOT REQUIRED

Additional Double Lock

10mm 1298 gr | Finishing .01 .02 .21

208

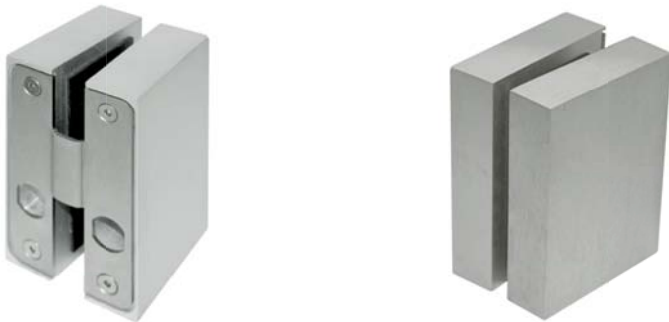

CODE 208		
Type of Lock	Glass Thickness	
		15mm
Additional Double Lock Female	208.15	208.20

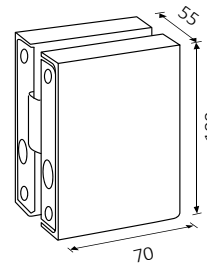

GLASS CUTTING NOT REQUIRED

Additional Double Lock Female [for lock 207]

10mm 845 gr | Finishing .01 .02 .21

210

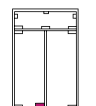
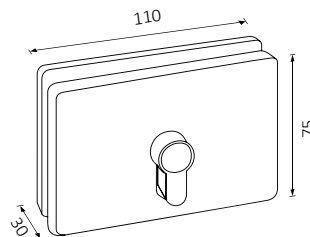

AVAILABLE WITH
• 2203 SECURITY CYLINDER
• 2204 CYLINDER WITH KNOB

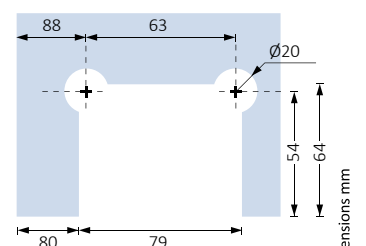

Floor Lock [Double Locking]

10mm* 689 gr | Cover finishing .01 .02 .07 .08 .13 .14 .21 .25

* Up to 12mm Glass, upon request

Dimensions mm

LOCKS

211

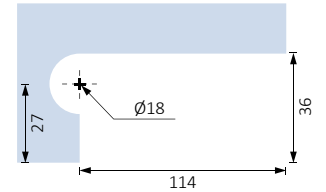
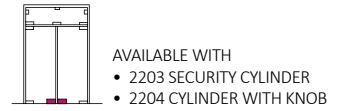
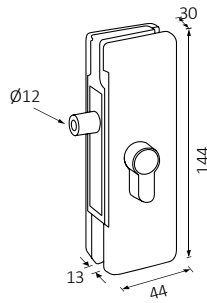

Side Lock

10mm* 623 gr | Cover finishing .01 .02 .07 .08 .13 .14 .21 .25
 * Up to 12mm Glass, upon request

212

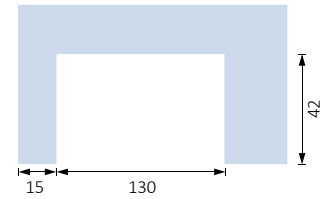
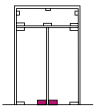
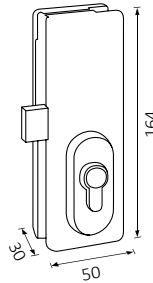

Side Lock

10-12mm 1163 gr | Cover finishing .13 .14

230

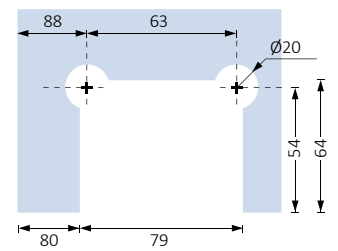
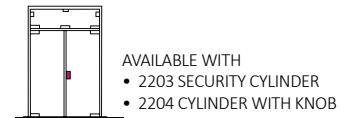
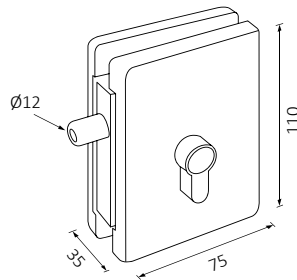

Front Side Lock [Double Locking]

10mm* 680 gr | Cover finishing .01 .02 .07 .08 .13 .14 .21 .25
 * Up to 12mm Glass, upon request

231

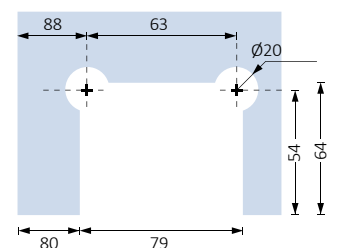
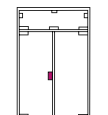
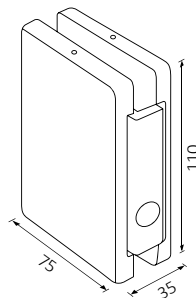

Front Side Lock Female [for side lock 230]

10mm* 356 gr | Cover finishing .01 .02 .07 .08 .13 .14 .21 .25
 * Up to 12mm Glass, upon request

VL 155C "Chameleon"

Vertical Glass Lock VL 155mm

8- 12,5mm 1770 gr

Finishing

Body, Handle, Cylinder Cover: .01 .21 .33

Decorative Mask .01 .21 .13 .14 .33

LEFT



AVAILABLE TYPES & APPLICATIONS

- FOR DOOR CASE LEFT - RIGHT
- FOR GLASS TO GLASS
- A/R
- WITH STOPPER [ONE WAY]

- Reversible direction Left & Right
- Double lock mechanism with 21mm dead bolt
- Handle alignment adjustment
- Various types of cylinders for multiple locking applications
- Various part finishing:
 - Lock body in natural or black anodized finishing
 - Decorative masks available in natural anodized, black anodized, satin & polish stainless steel

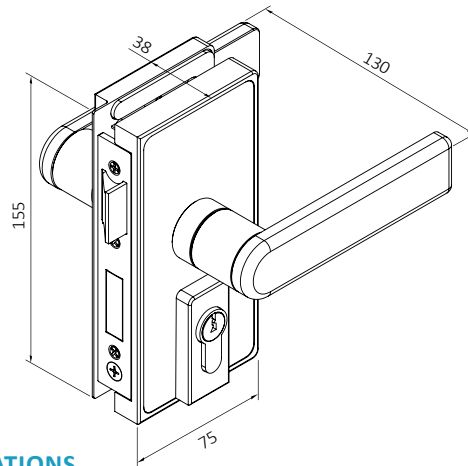

NEW!!

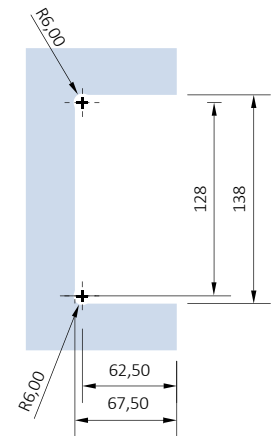

VL155FG

Additional Vertical Lock Combined with glass lock VL155 G



247

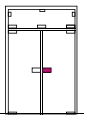
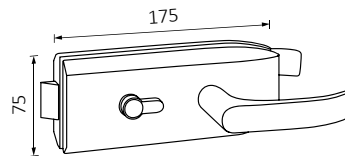

Front Lock with Handle

10mm 1763 gr | Finishing .15 .16

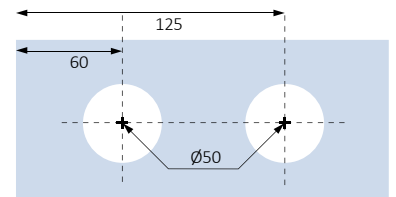

248

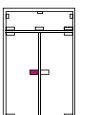
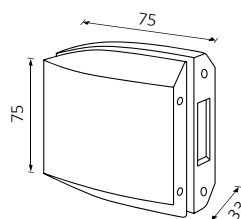

Female [for lock 247]

10mm 343 gr | Finishing .15 .16

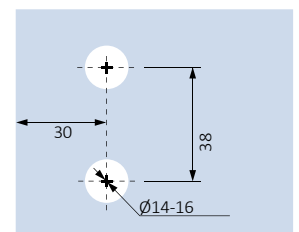

Dimensions mm

247G

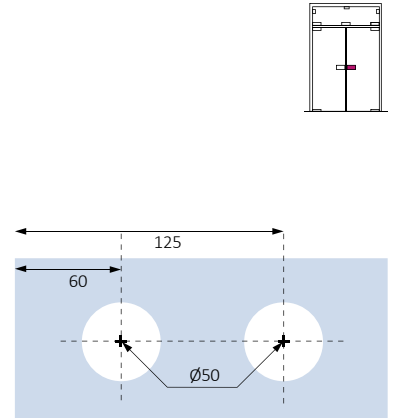
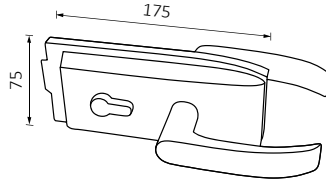

Mechanical Lock with Handle for G-W or Case

10mm 1705 gr | Finishing .16

243G

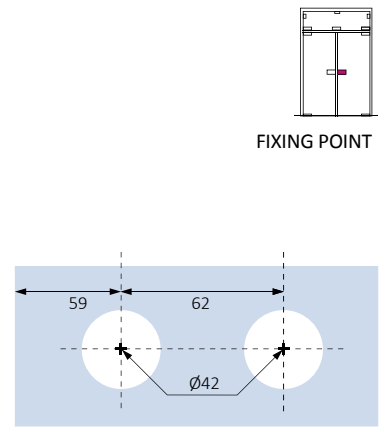
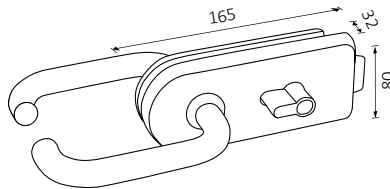
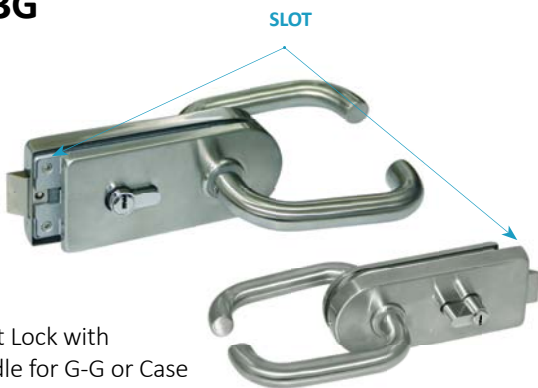

Front Lock with Handle for G-G or Case

10-12mm 1457 gr | Cover finishing .13 .14

244

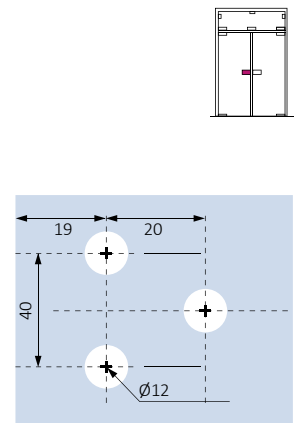
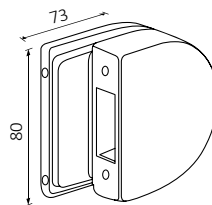

Female [for lock 243G]

10-12mm 203 gr | Cover finishing .13 .14

243

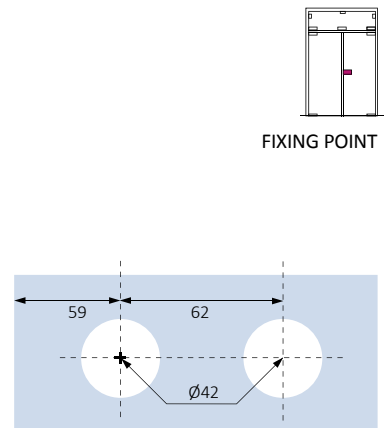
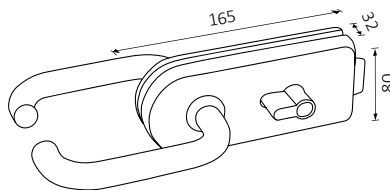

Front Lock with Handle for G-W

10-12mm 1457 gr | Cover finishing .13 .14

280WC



SWITCH STANDARD
PLASTIC BLACK

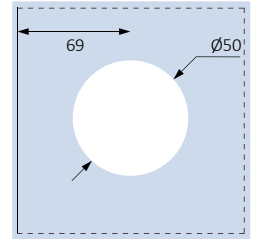
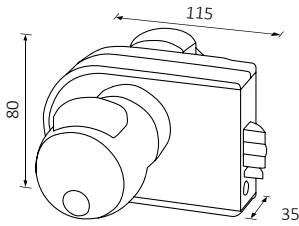
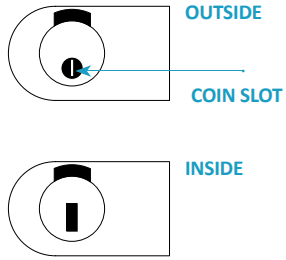

Glass Lock Meroni WC

10mm 762 gr | Finishing .07 .13 .21 RAL GREY COLOUR

280

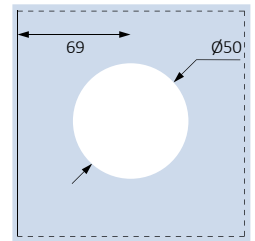
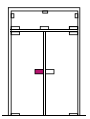
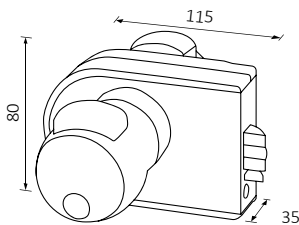
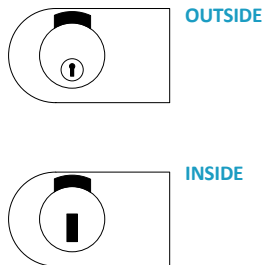

Glass Lock Meroni

10mm 762 gr | Finishing .07 .13 .21 RAL GREY COLOUR

281

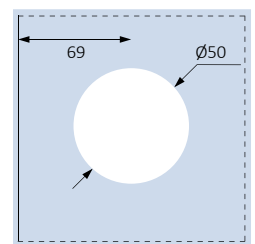
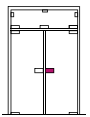
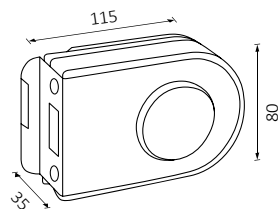

Glass Lock Meroni Female [for lock 280 & 280WC]

10mm 321 gr | Finishing .07 .13 .21 RAL GREY COLOUR

284

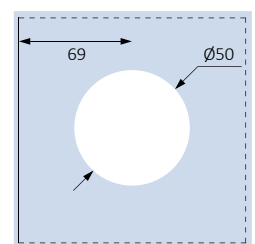
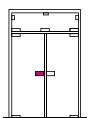
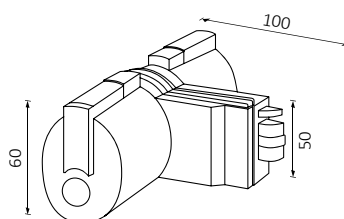
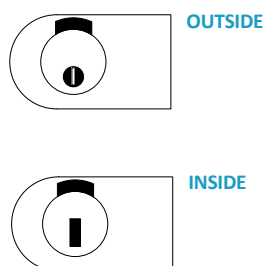

Glass Lock Meroni Forma

10mm 897 gr | Finishing .21 RAL GREY COLOUR

Dimensions mm

LOCKS

285

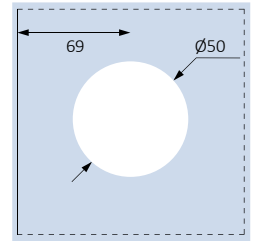
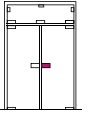
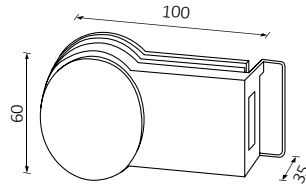

Glass Lock Meroni Female [for lock 284]

10mm 229 gr | Finishing .21 RAL GREY COLOUR

227

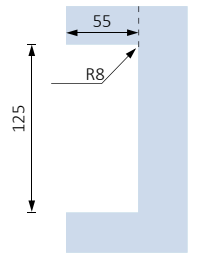
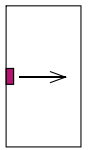
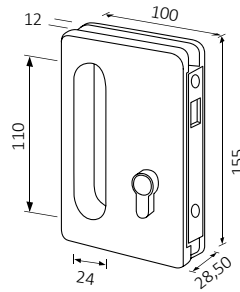

Lock for Sliding Door

10mm AL. 877 gr | Finishing .01 .03 .04 .25

228

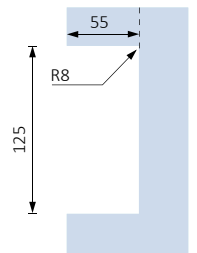
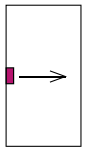
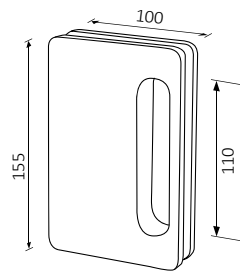

Lock Female for Sliding Door [for lock 227]

10mm AL. 877 gr | Finishing .01 .03 .04 .25

250

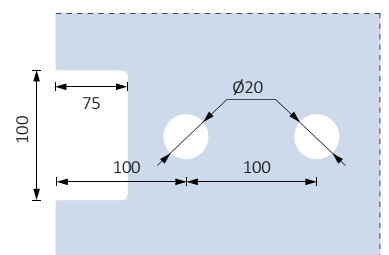
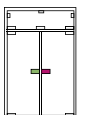
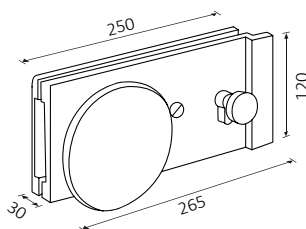

RIGHT

Electric Lock Left/Right

10mm 2300 gr | Finishing .01

252

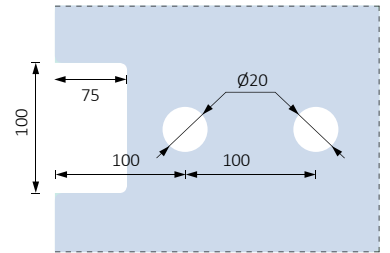
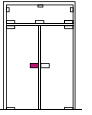
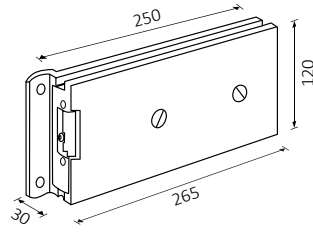

Electric Lock Female [for lock 250]

10mm 1600 gr | Finishing .01

GAUDI FIT IN



Electronic Lock
for Wooden Panel Doors

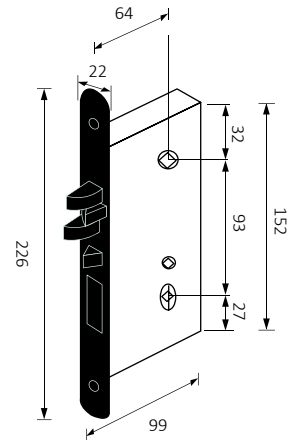

273



RIGHT

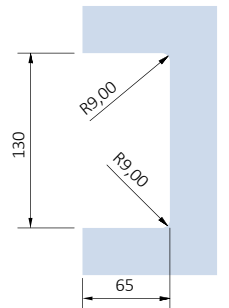
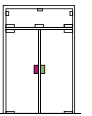
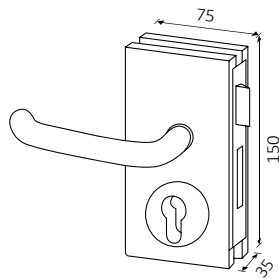

Electric Lock with Knob Left/Right

10mm 1393 gr | Cover finishing .13 .14

275



LEFT

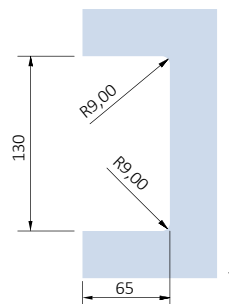
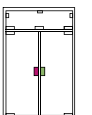
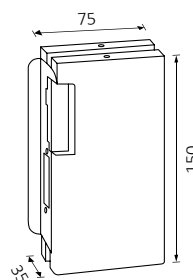

Female [for lock 273] Left/Right

10mm 957 gr | Cover finishing .13 .14

Dimensions mm

LOCKS

254

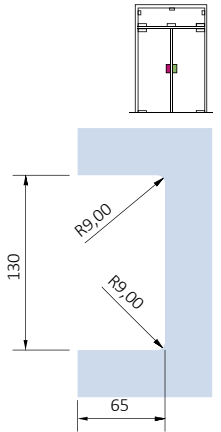
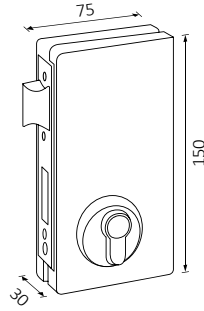

Electric Lock CSM Left/Right

10mm 1283 gr | Cover finishing .01

256

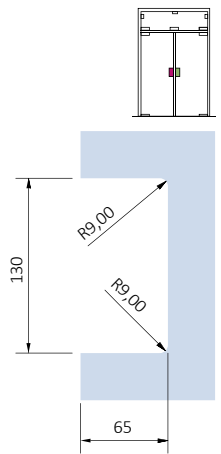
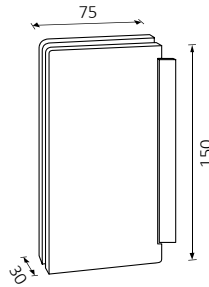

Electric Lock CSM Female [for lock 254] Left/Right

10mm 749 gr | Cover finishing .01

270

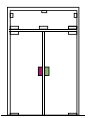
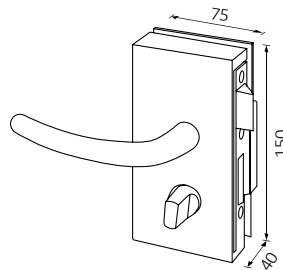

RIGHT

GLASS CUTTING NOT REQUIRED

Additional Electric Lock Left/Right

10mm 1282 gr | Cover finishing .09

272

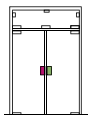
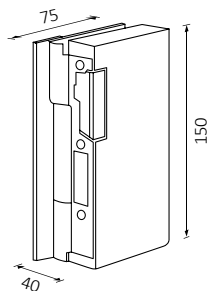

LEFT

GLASS CUTTING NOT REQUIRED

Additional Electric Lock Female [for lock 270] Left/Right

10mm 891 gr | Cover finishing .09

lock casing & floor plates

109



Lock Floor Plate

Finishing .01 .13 .14

111



Lock Casing Ø8

17 gr | Finishing .13

113



Lock Casing Ø12 Double Lock

22 gr | Finishing .13

covers for locks

2101

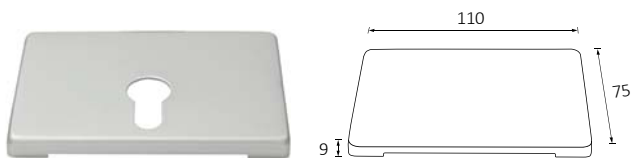

Cover [for lock 210]

24-63 gr | Finishing .01 .02 .07 .08 .13 .14 .21 .25

2102

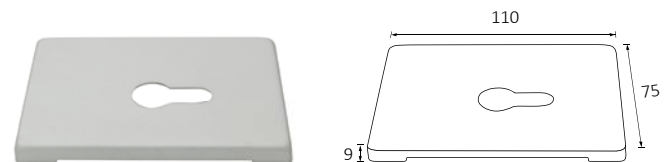

Front Side Cover [for lock 230]

25-59 gr | Finishing .01 .02 .07 .08 .13 .14 .21 .25

2103



Cover for Supports [for 401-402]

23 gr | Finishing .07 .08 .13 .14 .21 .25

2106

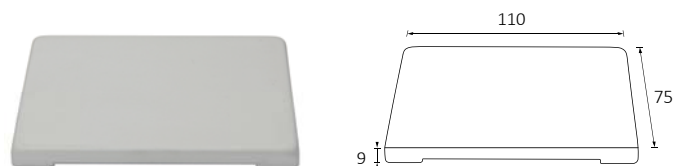

Cover for Front Side Female [for 231]

27-61 gr | Finishing .01 .02 .07 .08 .13 .14 .21 .25

261

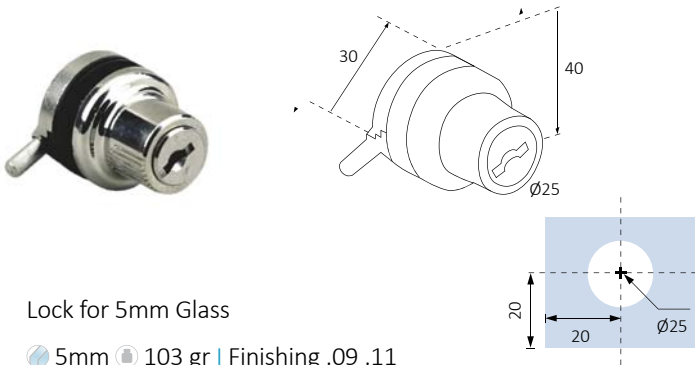

Lock for 5mm Glass
 5mm 103 gr | Finishing .09 .11

262

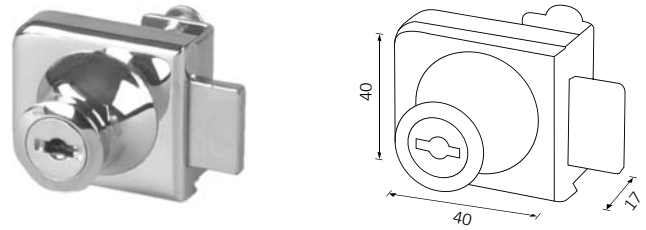

Additional Single Glass Lock 5mm
 5mm 97 gr | Finishing .09 .11

263

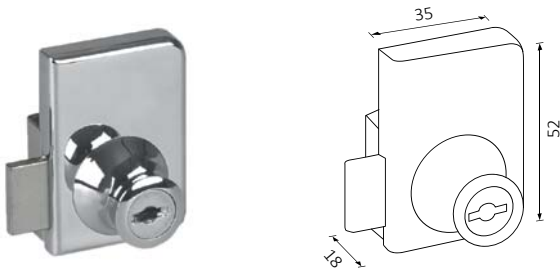

Additional Double Glass Lock 5mm
 5mm 116 gr | Finishing .09

264

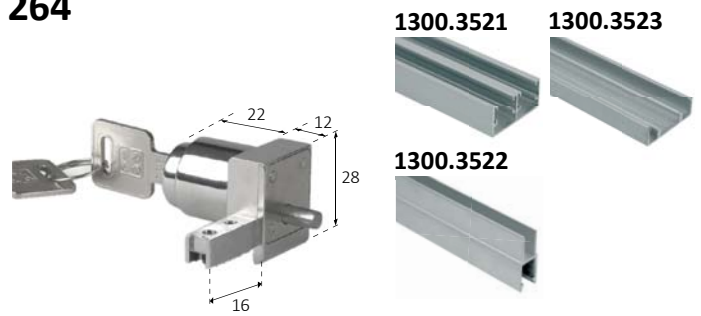

Lock for Sliding Door 5mm with profile [CODE 1300, page 78]
 5mm 90 gr | Finishing .09

265

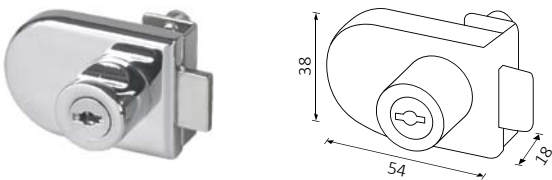

Additional Single Glass Lock 5mm
 5mm 139 gr | Finishing .09

266



Female of Additional Single Glass Lock 5mm
 5mm 43 gr | Finishing .09

267



33 LOCKING POSITIONS
 Lock for 5mm Glass Sliding Door
 62 gr | Finishing .09

268

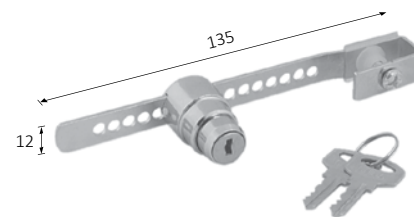

16 LOCKING POSITIONS
 Lock for 5mm Glass Sliding Door
 78 gr | Finishing .09



bolts

BOLTS

900

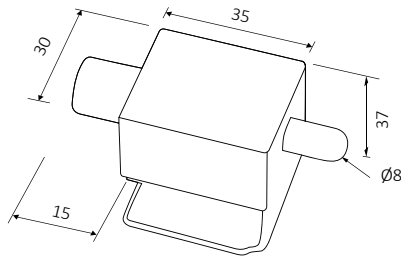

GLASS CUTTING NOT REQUIRED

Additional Bolt Male

10mm 193 gr | Finishing .13 .14

901

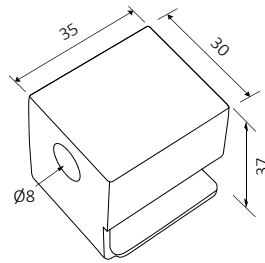

GLASS CUTTING NOT REQUIRED

Additional Bolt Female [for bolt 900]

10mm 175 gr | Finishing .01 .21 .25

910

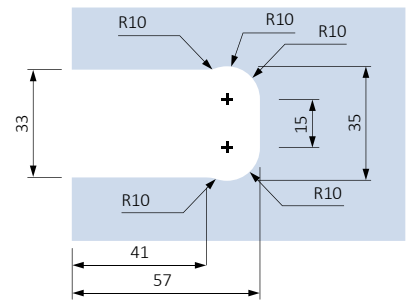
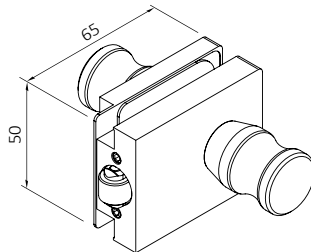

Door catcher with knob

10mm 297 gr | Finishing .01 .21 .25

Suitable for INAL door case series profiles
Elegance, Flexi, Simply

910C

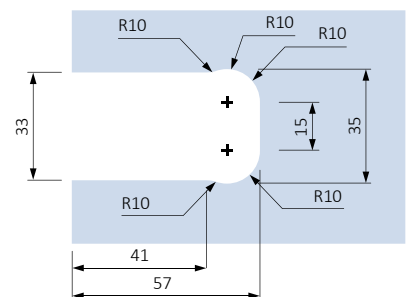
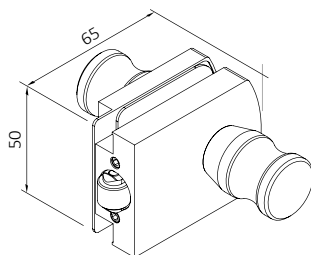

Door catcher curved design with knob

10mm 297 gr | Finishing .01 .21 .25

Suitable for INAL door case series profiles
Elegance, Flexi, Simply

903G

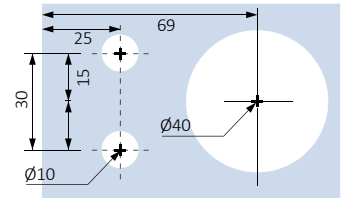
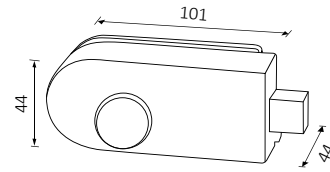
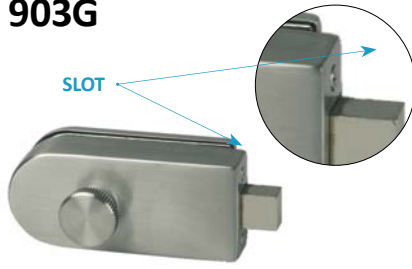

Bathroom Bolt Male with indication

10mm 428 gr | Cover finishing .13 .14

Suitable for INAL door case series profiles
Elegance, Flexi

903



WITH INDICATION

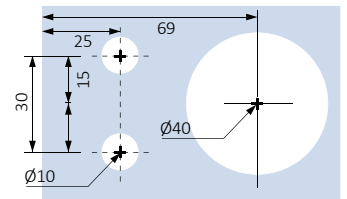
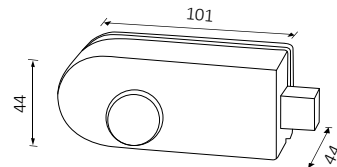

Bolt Male with indication [for WC]

10mm 428 gr | Cover finishing .13 .14

904

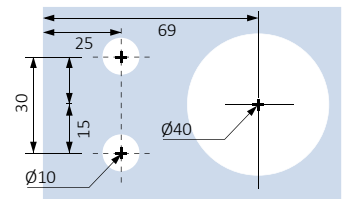
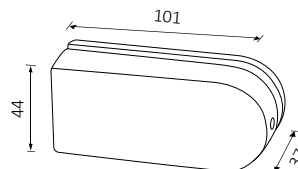

Bolt Female [for bolt 903]

8-10mm 302 gr | Cover finishing .13 .14

908

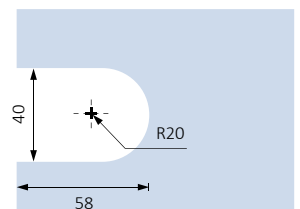
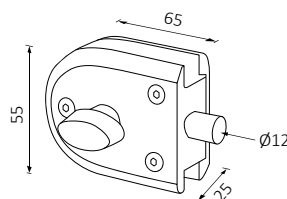

Bolt Male

10mm 319 gr | Finishing .15 .16

Dimensions mm

BOLTS

909

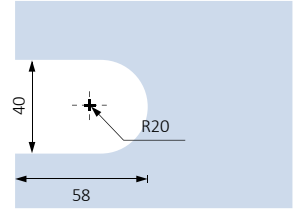
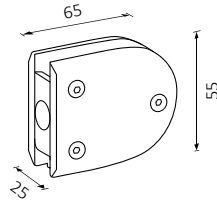

Bolt Female [for bolt 908]

10mm 248 gr | Finishing .15 .16

911

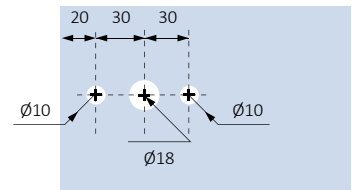
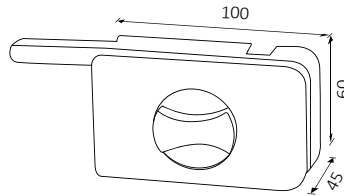

Heavy Duty Bolt Male

10-16mm 525 gr | Finishing .01 .21 .25

912

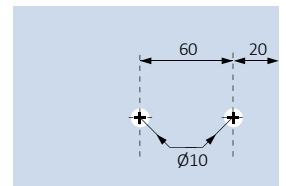
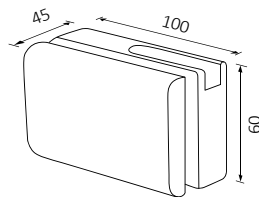

Heavy Duty Female [for bolt 911]

10-16mm 535 gr | Finishing .01 .21 .25

911.SQ

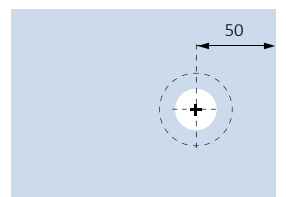
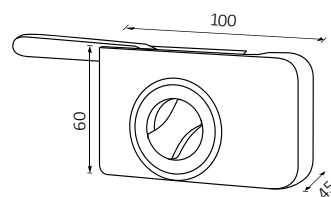

COMBINED WITH HINGE 152

Squash Bolt Male

10-16mm 525 gr | Finishing .01 .21 .25

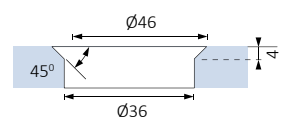

Dimensions mm



electric locks



ELECTRIC LOCKS

1581

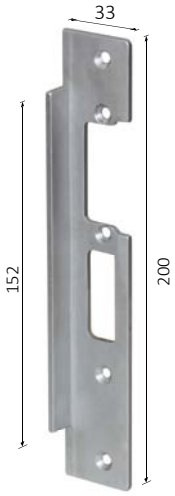
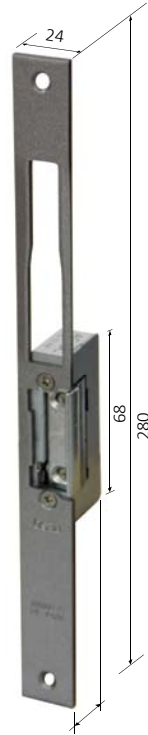

Plate [for strike 290] R/L

● 53 gr

290



Electric Strike 12V DC

● 281 gr

934

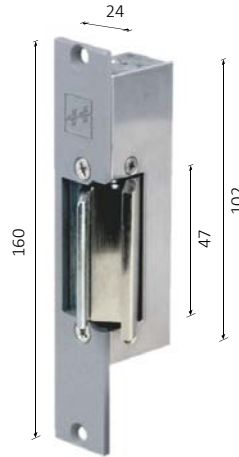

Electric Strike EFF-EFF Self Secure 12V DC for Glass

● 10mm ● 340 gr

924



Electric Strike Self Secure 12V DC for Glass

● 10mm ● 313 gr

295

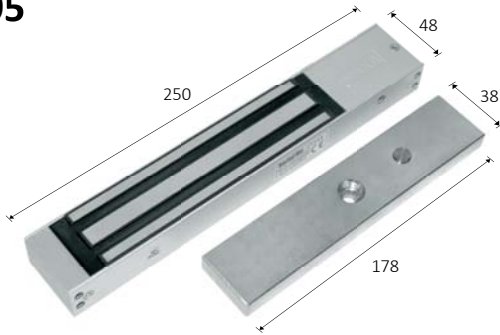

Electromagnetic Lock 12V DC

● 1830 gr | Finishing .01 **280Kgr [Force]**

297



Additional Support clamp [for plate 295]

● 10-12mm ● 365 gr | Finishing .13 .14

298



Additional Electric Bolt AL/R [BOLT FAIL SAFE] 12V DC

● 10-20mm* ● 2108 gr

* Up to 20mm Glass

9334VGL



UPON REQUEST

Additional Electric Strike EFF-EFF 12V DC for Glass

● 10mm ● 1150 gr | Finishing .01

294E

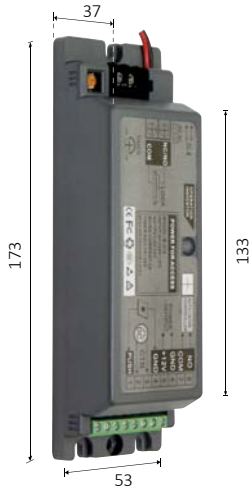

Transformer 12V DC

● 198 gr
Suitable for all electric locks

296E



Receiver with Remote Control

● 124 gr
Suitable for all electric locks

258



Transformer 12V DC KIT

● 679 gr
Suitable for all electric locks, connection with card reader 299 E

259



Transformer 12V DC KIT with receiver & remote control

● 810 gr
Suitable for all electric locks, connection with card reader 299 E

299E



Proximity Card Reader 12V DC
MAX 1000 Cards

● 104 gr

1700E

EXTRA REMOTE CONTROL



Remote Control

293



Card

EXTRA CARDS

291A

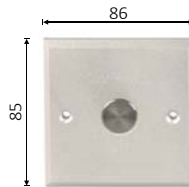

Button [Internal Use]

● 164 gr
Suitable for all electric locks

291C



Button [Internal Use]

● 67 gr
Suitable for all electric locks

291B

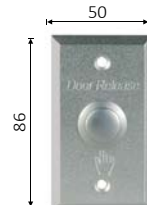

Button [Internal Use]

● 100 gr
Suitable for all electric locks

292



Button Key [External]

● 18 gr
Suitable for all electric locks

! Noscavo Hydraulic Hinge Closer
• page 76



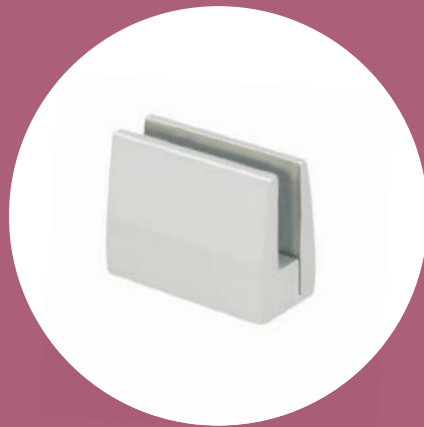

clips

CLIPS

401

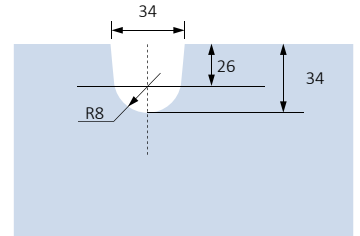
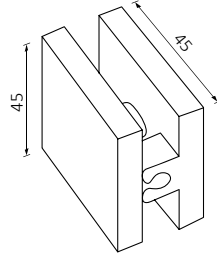

Wall to Glass Support

8-12mm 98 gr | Finishing .01 .02 .11 .13 .14 .21 .25

402

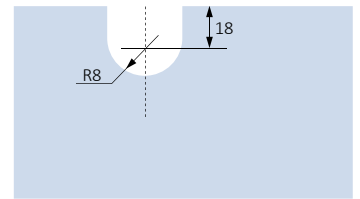
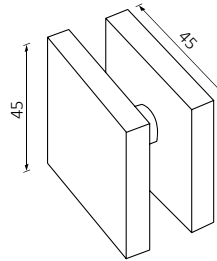

Glass to Glass Support

8-12mm 93 gr | Finishing .01 .02 .11 .13 .14 .21 .25

403 [STAINLESS STEEL]

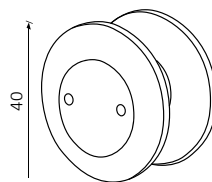
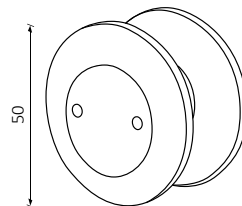

	8-12mm	Ø	98 gr
403.4010.13	10 mm	Ø40	80 gr
403.4010.14	10 mm	Ø40	80 gr
403.4012.13	12 mm	Ø40	83 gr
403.4012.14	12 mm	Ø40	83 gr
403.4015.13	15 mm	Ø40	85 gr
403.4015.14	15 mm	Ø40	85 gr
403.4020.13	20 mm	Ø40	90 gr
403.4020.14	20 mm	Ø40	90 gr
403.5010.13	10 mm	Ø50	120 gr
403.5010.14	10 mm	Ø50	120 gr
403.5012.13	12 mm	Ø50	123 gr
403.5012.14	12 mm	Ø50	123 gr
403.5015.13	15 mm	Ø50	125 gr
403.5015.14	15 mm	Ø50	125 gr
403.5020.13	20 mm	Ø50	130 gr
403.5020.14	20 mm	Ø50	130 gr

Round Glass to Glass Support Stainless Steel Ø40mm and Ø50mm

10-20mm | Finishing .13 .14

405

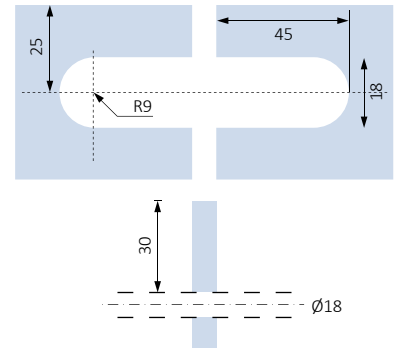
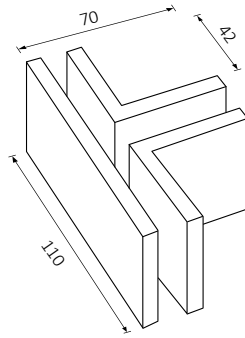
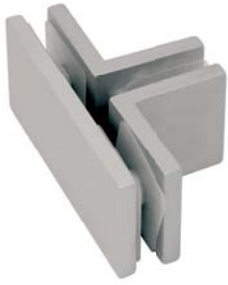

T-Shape Support

8-10mm 342 gr | Finishing .01 .02 .21 .25

406

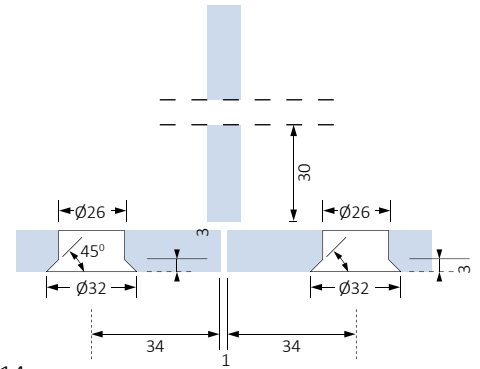
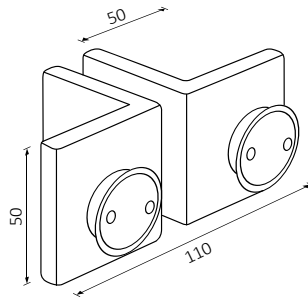

T-Shape Support [Squash]

8-16mm 273 gr | Finishing .01 .02 .21 .25 | Round Cup: Stainless steel Finishing .13 .14

407

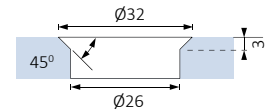
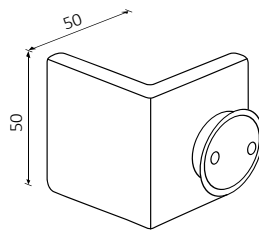

Angle Glass to Wall Support [Squash]

8-16mm 131 gr | Finishing .01 .02 .21 .25 | Round Cup: Stainless steel Finishing .13 .14

408

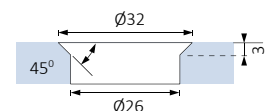
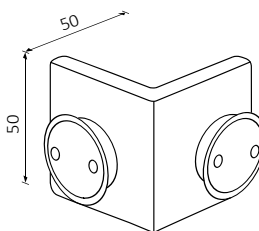

Angle Glass to Glass Support [Squash]

8-16mm 131 gr | Finishing .01 .02 .21 .25 | Round Cup: Stainless steel Finishing .13 .14

414

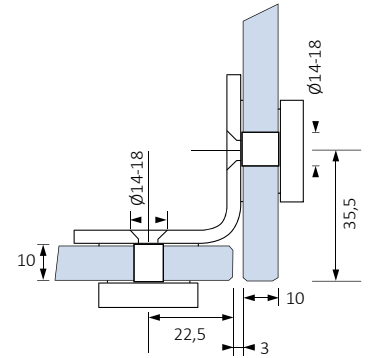
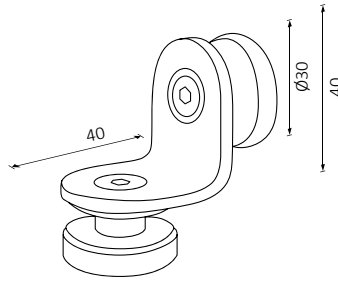

Round Angle 90° Support Glass to Glass

8-12mm 150 gr | Finishing .09 .10

415

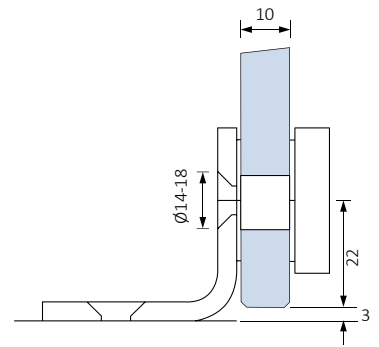
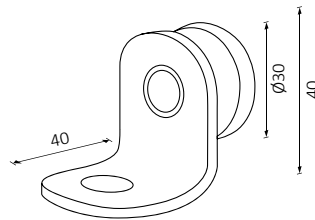

Round Angle 90° Support Glass to Wall

8-12mm 102 gr | Finishing .09 .10

416

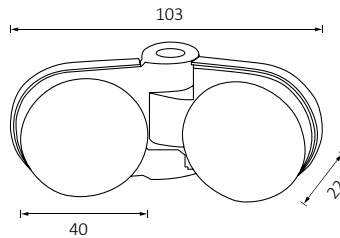

Adjustable Angle Support Glass to Glass

8-12mm 383 gr | Finishing .09 .10

ATTENTION

THE GLASS HOLES DEPEND ON THE DEGREE OF THE ANGLE

461

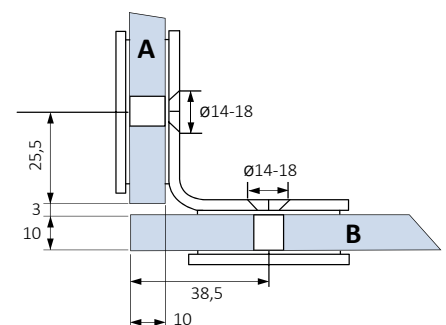
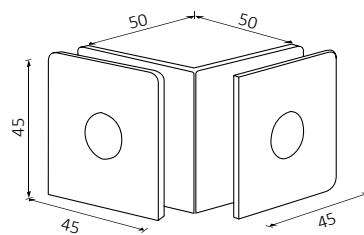

Angle Glass to Glass Support

8-12mm 259 gr | Finishing .13 .14

463

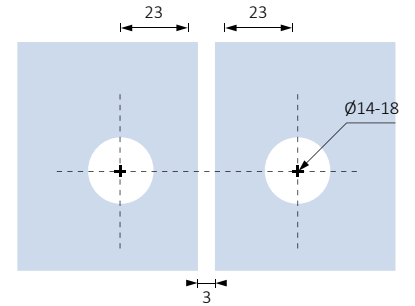
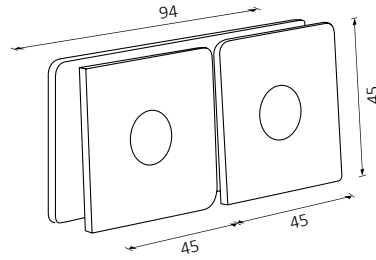

Double Support

8-12mm 259 gr | Finishing .13 .14

464

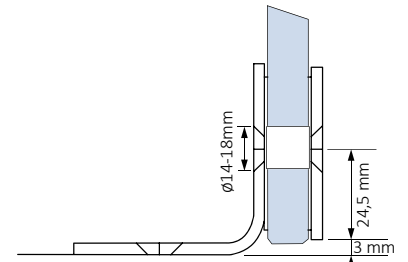
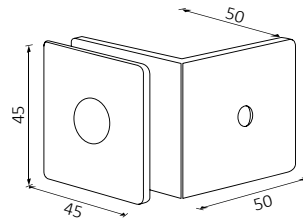

Angle Glass to Wall Support

8-12mm 193 gr | Finishing .13 .14

471

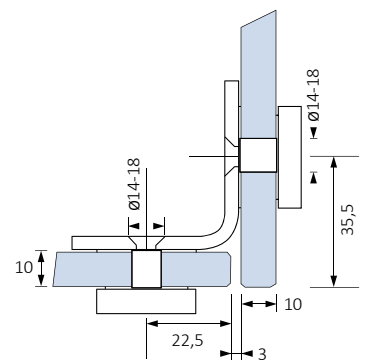
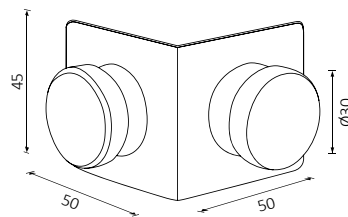

Angle Support [With Plugs] Glass to Glass

8-12mm 230 gr | Finishing .13 .14

472

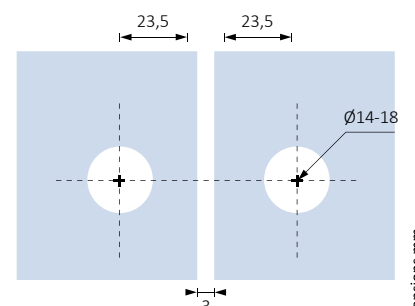
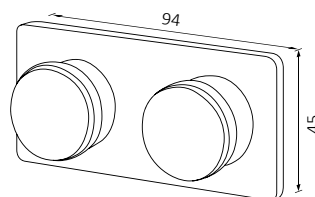

Double Support [With Plugs]

8-12mm 197 gr | Finishing .13 .14

Dimensions mm

474

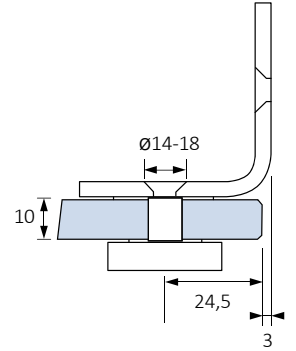
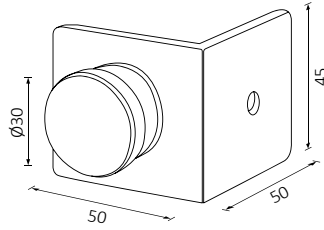

Angle Support [With Plugs] Glass to Wall

8-12mm 182 gr | Finishing .13 .14

1620.414045.14

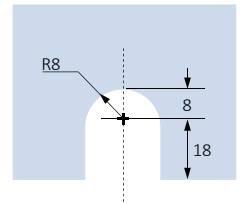
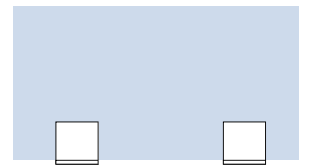
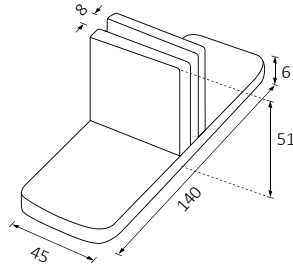

Fireplace Glass Clip base

6/10mm 541 gr | Finishing .14

412

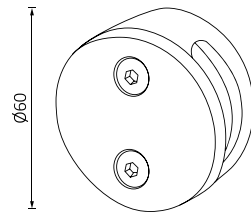

412

Round Clamp Stainless Steel, Ø60mm, for tube Ø42, 4mm

AISI 316 10mm 366 gr | Finishing .13 .14

10mm

413

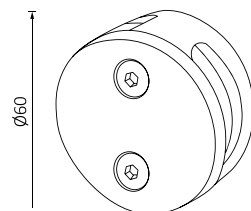

413

Round Clamp Stainless Steel, Ø60mm, for tube Ø42,4mm

AISI 316 10mm 398 gr | Finishing .13 .14

10mm

410 [ZINC ALLOY]

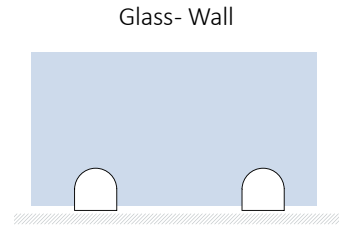
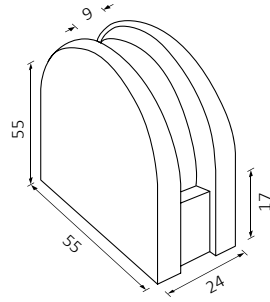

Zinc Alloy Clamp With Flat Base 55mm

8-10mm 170 gr | Finishing .15 .16

411 [ZINC ALLOY]

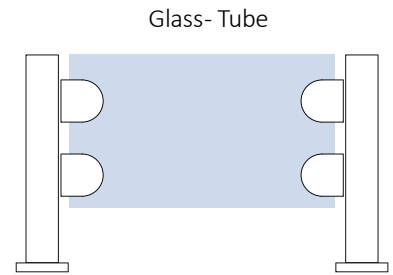
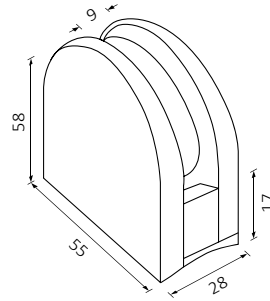

Zinc Alloy Clamp 55mm

8-10mm 179 gr | Finishing .15 .16

410 [STAINLESS STEEL]



Glass Stopper

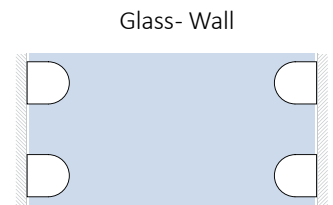
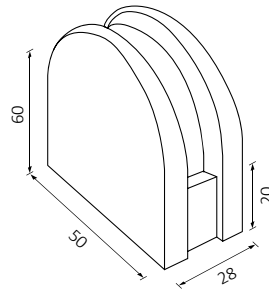

Clamp Large Stainless Steel 50mm

8-13mm 247 gr | Finishing .13 .14

411 [STAINLESS STEEL]



Glass Stopper

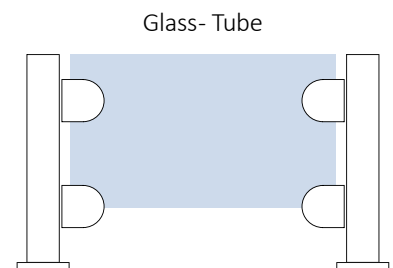
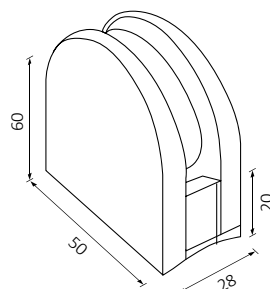

Clamp Large Curved Base 50mm Stainless Steel

8-13mm 238 gr | Finishing .13 .14

Dimensions mm

850 [ALUMINUM]

Dimensions mm

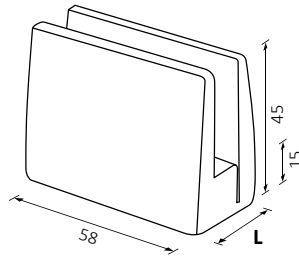

Wall-Self Glass Support | Finishing .01 .02 .21 .25

		L	
850.10	8- 10 mm	28 mm	125 gr
850.15	12- 16 mm	34 mm	137 gr
850.20	18- 20 mm	38 mm	147 gr

850 [STAINLESS STEEL]

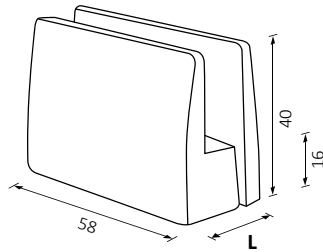

Wall-Self Glass Support | Finishing .13 .14

		L	
850.10	8- 10 mm	24 mm	195 gr
850.15	12- 16 mm	30 mm	220 gr
850.20	18- 20 mm	35 mm	265 gr



! Glass Locks
• page 31



support & spacers

801

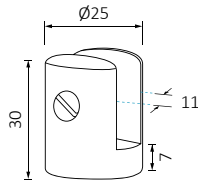

Glass-Self Support $\varnothing 25 \times 30$

8-10mm 67 gr | Finishing .09 .10 .11

809

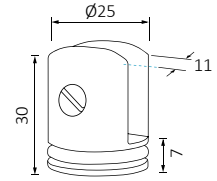

LIMITED AVAILABILITY

Glass-Self Support $\varnothing 25 \times 30$

8-10mm 65 gr | Finishing .09 .10 .11

802

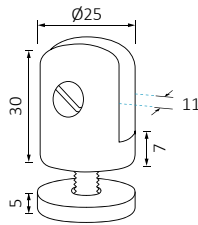

Glass-Self Support with End Stop $\varnothing 25 \times 35$

8-10mm 98 gr | Finishing .09 .10 .11



803

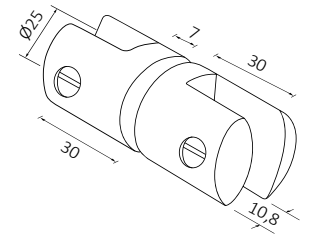

Double Glass-Self Support $\varnothing 25 \times 30$

8-10mm 138 gr | Finishing .09 .10 .11



806

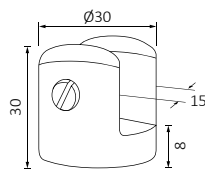

Glass Self-Support $\varnothing 30 \times 30$, 15mm

15mm 86 gr | Finishing .09 .10 .11

821

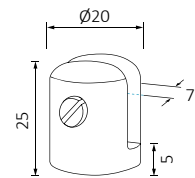

Small Glass-Self Support 5mm $\varnothing 20 \times 25$

5mm 38 gr | Finishing .09 .10 .11

810

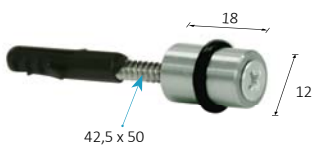

Wall-Self Support $\varnothing 12$

13 gr | Finishing .09 .10 .11

811

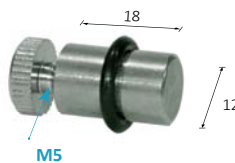

Self Support with End Stop $\varnothing 12$

20 gr | Finishing .09 .10 .11

812

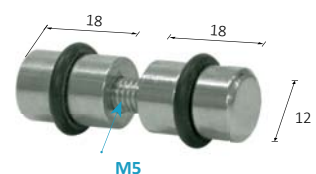

Double Self Support $\varnothing 12$

32 gr | Finishing .09 .10 .11

804



Wall-Self Support 30mm / Door Stop

● 128 gr | Finishing .09 .10 .11

890



Mirror Support Ø32

● 4-6mm ● 46 gr | Finishing .09 .10 .11

816

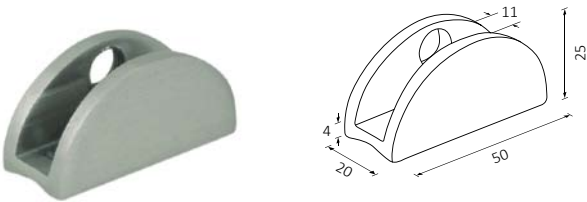

Support [Half Moon] 50mm

● 8-10mm ● 79 gr | Finishing .09 .10 .11

817



Support [Half Moon] Small 30mm

● 8-10mm ● 52 gr | Finishing .09 .10 .11

818

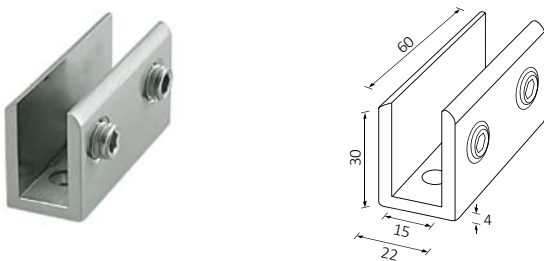

Rectangular Support 60mm

● 8-10mm ● 110 gr | Finishing .15 .16

818LP.08

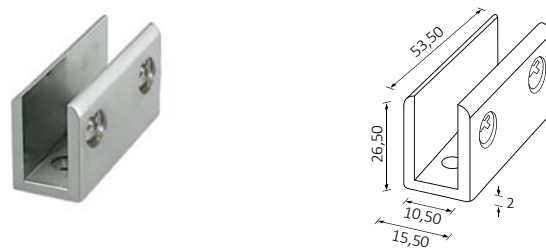

Rectangular Support

● 6-8mm ● 54 gr | Finishing .15 .16

819

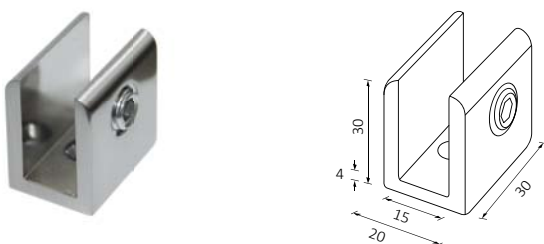

Rectangular Small Support 30mm

● 8-10mm ● 56 gr | Finishing .15 .16

819LP.08



Rectangular Small Support

● 6-8mm ● 36 gr | Finishing .15 .16

826

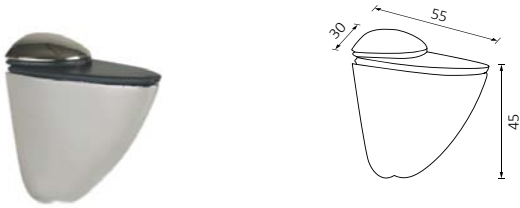

Glass-Self Support Small 55mm

5-16mm 44 gr | Finishing .09 .10

827



Glass-Self Support Medium 75mm

5-20mm 90 gr | Finishing .09 .10

828

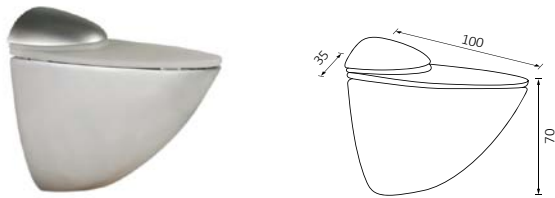

Glass-Self Support Heavy Duty 100mm

5-20mm 166 gr | Finishing .09 .10

831



Glass-Self Support 20x20 made of Glass

17 gr

832



Glass-Self Support made of glass Ø22

16 gr

880



		L	
880.20	5 - 12 mm	20 mm	95 gr
880.30	5 - 16 mm	30 mm	125 gr
880.50	5 - 20 mm	50 mm	181 gr

Spacer Ø25 | Finishing .09 .10 .11



881



		L	
881.20	8 - 10 mm	20 mm	141 gr
881.30	8 - 10 mm	30 mm	172 gr
881.50	8 - 10 mm	50 mm	229 gr

Glass-Self Spacer Ø25 | Finishing .09 .10 .11

1656



Stair Support Ø30

54 gr | Finishing .14

310-08/32



Cone Head PLR Ø32-M8 & Ø46-M8, Stainless Steel

27 gr | Finishing .13 .14

310-08/46

310-08/32 Ø32-M8-L10

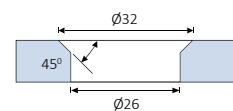

310-08/46 Ø46-M8-L12

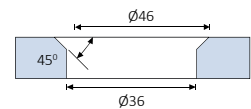

882

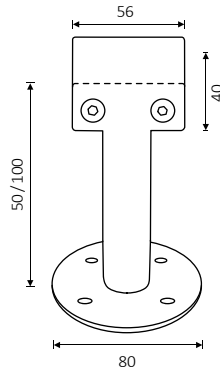

Fixed Dimensions 50mm and 100mm

Fixed Stainless steel Spacer 100mm & 50mm

AISI 316 for Glass 8-10mm, 12-16mm, 18-20mm | Finishing .13 .14

883

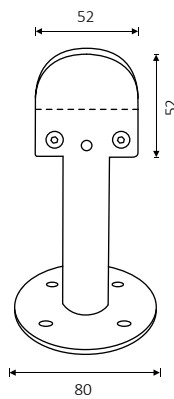

Fixed Dimensions 50mm and 100mm

SPECIAL DIMENSIONS UPON REQUEST

Fixed Curved Stainless steel Spacer 100mm & 50mm

AISI 316 for Glass 8mm~13mm | Finishing .13 .14

885.45 ADJUSTABLE

Adjustment

from 45 up to 65mm

M10

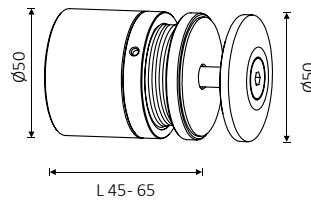

AVAILABLE FOR GLASS 8-20mm

Adjustable Glass Spacer, Stainless steel,
Metal Anchor M12, Screw M12x90

AISI 316 589 gr | Finishing .13 .14

Ø20- Ø25



884.40/50

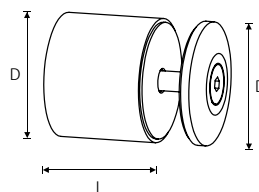
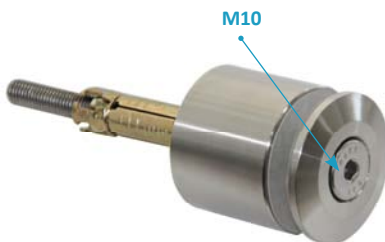

CODE	D	L
884.30/40	40	30
884.30/50	50	30
884.40/40	40	40
884.40/50	50	40

Fixed Spacer for 8-20mm Glass, Stainless Steel

AISI 316 AISI 304 683 gr | Finishing .13 .14

Ø20- Ø25

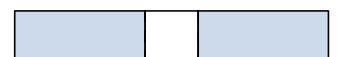

Dimensions mm

Glass Door Handle
page 62

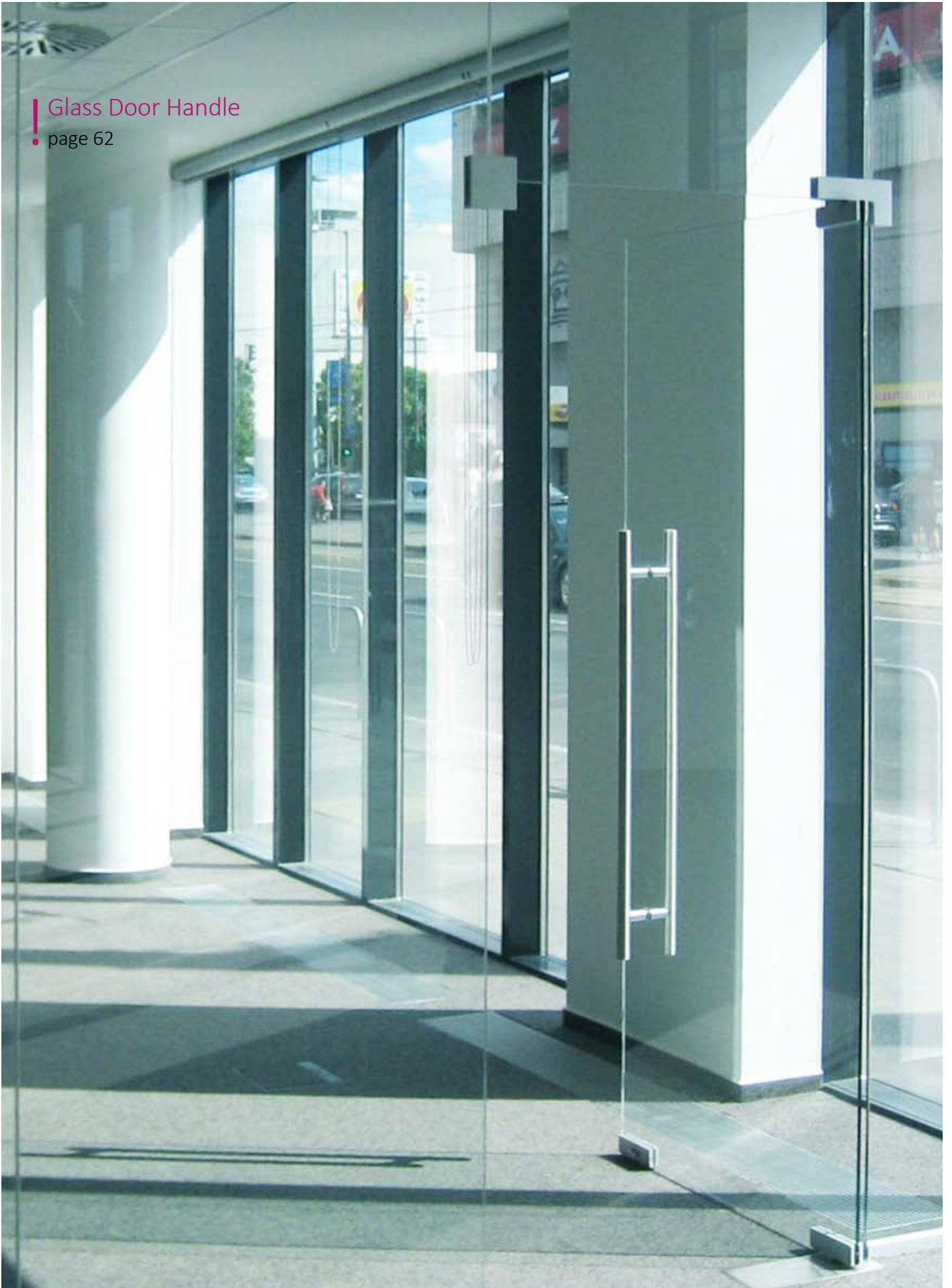

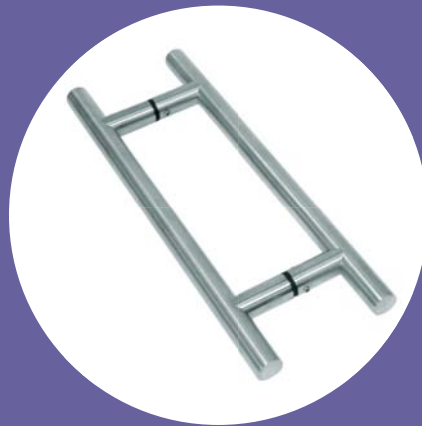

handles

HANDLES

601



Round Glass Door Handle
Ø150x15mm

1565 gr | Finishing .13 .14

602



Octagon Glass Door Handle
15mm

1560 gr | Finishing .13 .14

605



Round Glass Door Handle
Ø90x15mm

835 gr | Finishing .13 .14

606



Opaque Satin Round Glass Door
Handle Ø150x15mm

1418 gr | Finishing .13 .14

624



Rod for Handle Stainless steel
Finishing .13

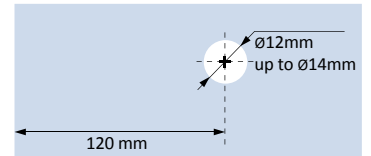
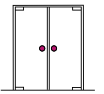

Cutting and hole for 601, 602,
605, 606, and cone head 624

609



Round Glass Door Handle Ø40

177 gr | Finishing .09



610

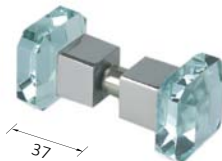

Prismatic Glass Door Handle 35x35

206 gr | Finishing .09



619



GLASS HOLE
619.50: Ø50
619.60: Ø60

	619.50	619.60
619.50.14	6-11,52mm	166 gr
619.60.14	8- 12mm	261 gr

Door Handle Stainless Steel
Finishing .14

604.40



Door Handle Ø40

627 gr | Finishing .01 .13 .14 .21



604.50



Door Handle Ø50

1236 gr | Finishing .01 .13 .14 .21



604.75



Door Handle Ø75

895 gr | Finishing .23 .24

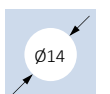

627.38



Door Handle Ø38

⊕ 626 gr | Finishing .01 .03 .04

623.30



Handle for Shower Ø30

⊕ 288 gr | Finishing .13 .14

628.30

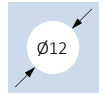

Handle for Shower Ø30

⊕ 344 gr | Finishing L=30 mm .03 .04
L=34 mm .13 .14

622.30



Handle for Shower Ø30

⊕ 286 gr | Finishing L=30 mm .03 .04
.13 .14

629.32



Round Handle Ø32

⊕ 106 gr | Finishing .03

629.50

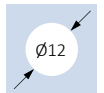

Round Handle Ø50

⊕ 396 gr | Finishing .03

612.40



Handle Opaque Satin Glass Ø40

⊕ 215 gr | Finishing .09

612.50



Handle Opaque Satin Glass Ø50

⊕ 407 gr | Finishing .09

613.40

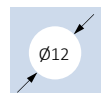

Glass Handle Ø40

⊕ 214 gr | Finishing .09

614.25



Glass Handle Sphere

⊕ 17 gr

615.22



Glass Handle Ø22x25

⊕ 22 gr

640

DIAMETER	L [LENGTH]	C [CENTER]
Ø32	500	360
	700	500
	1000	800
	1200	1000
	1400	1200
	1800	1600

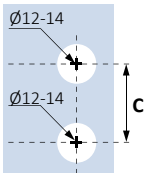

Stainless steel Handle H Ø32
Finishing .13 .14

640.18

DIAMETER	L [LENGTH]	C [CENTER]
Ø18	195	145
	250	150
	300	200
	350	250

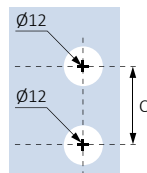

Stainless steel Handle H Ø18
Finishing .13 .14

631

DIAMETER	L [LENGTH] / C [CENTER]
Ø32	360
	500
	600
	800
	900
	1200
	1600
	1800

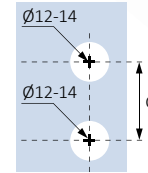

Stainless steel Handle "Π"
Finishing .13 .14

644

DIAMETER	L [LENGTH]	C [CENTER]
Ø32	500	360
	700	500
	1000	800
	1200	1000
	1400	1200
	1800	1600
Ø18	195	145
	250	150
	300	200
	350	250



for Ø18

for Ø32

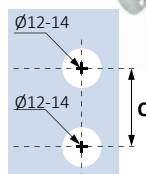
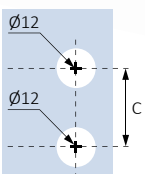

Stainless steel Handle Ø18 & Ø32 Single
with cap and handle | Finishing .13 .14

646

DIAMETER	L [LENGTH]	C [CENTER]
Ø32	500	360
	700	500
	1000	800
	1200	1000
	1400	1200
	1800	1600
Ø18	195	145
	250	150
	300	200
	350	250



for Ø18

for Ø32

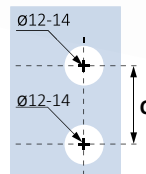
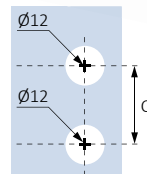

Stainless steel Handle Ø18 & Ø32 Single
with caps | Finishing .13 .14

644.2545.13

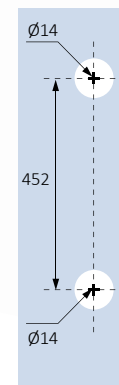

Stainless steel Handle Single "Π"
Finishing .13

651.45/28.13

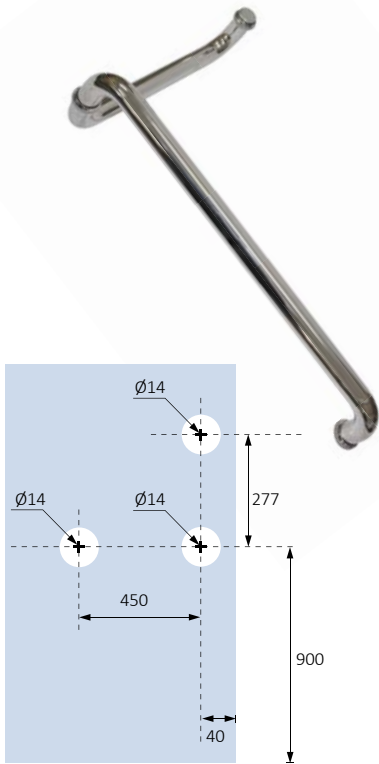

Stainless steel Shower Handle 450 x 280mm
Finishing .13 .14

651.45/25.13

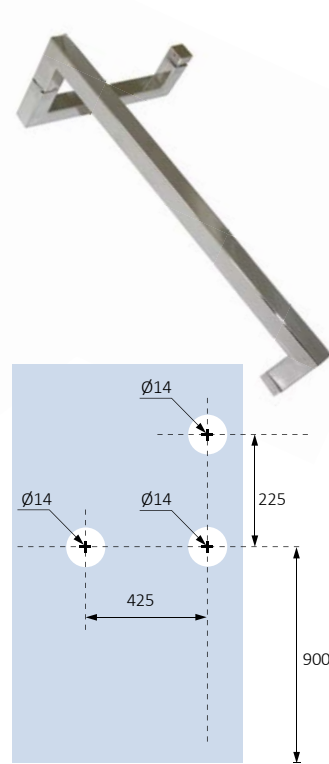

Stainless steel Shower Handle "2Π"
Finishing .13

**643.2550.13 643.2570.13
643.2580.13**

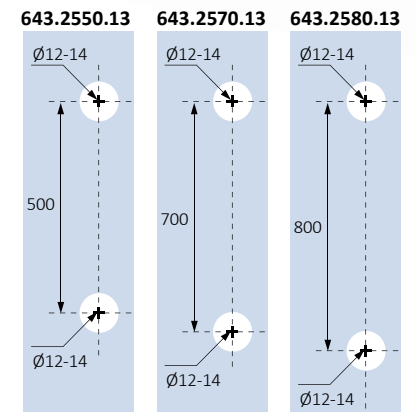

Stainless steel Shower Handle "Π"
Finishing .13

642



643

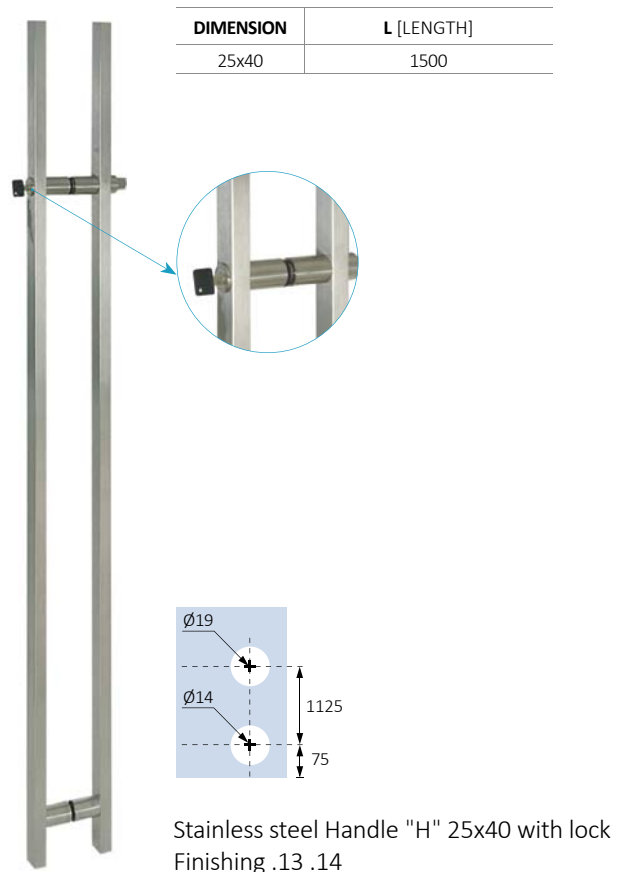

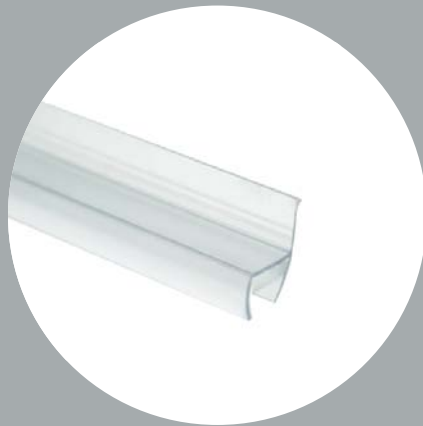

proofing

752

Aluminum Bar Housing 90o L/M

190 gr/m | Finishing .01 .21 .25

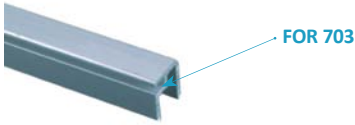

751

Aluminum Bar Housing

90 gr/m | Finishing .00 .01 .21 .25 .45

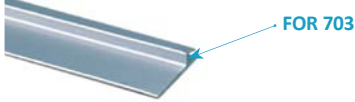

703

Brush L18-L35-L50 L 1,0m

75-89 gr/m

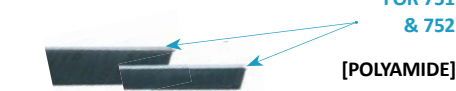

701

Brush Aluminum Bar
Finishing .01 .21 .25

	⊙	L [m]	⊙	
701.22	10	2,20	365 gr	
701.25	10	2,50	415 gr	
701.30	10	3,00	500 gr	
701.55	10	5,50	910 gr	

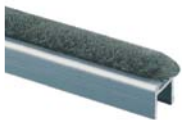

1400/1440

Profile "h"

	⊙	L [m]	⊙	
1400.10.25	10	2,50	190 gr	PVC+UV
1400.10.30	10	3,00	225 gr	PVC+UV
1400.12.25	12	2,50	190 gr	PVC+UV
1400.12.30	12	3,00	225 gr	PVC+UV
1400.12.35	12	3,50	260 gr	PVC+UV
1440.10.25	10	2,50	190 gr	POL/TE
1440.10.30	10	3,00	225 gr	POL/TE
1400.10.30BLACK	10	3,00	230gr	PVC+UV

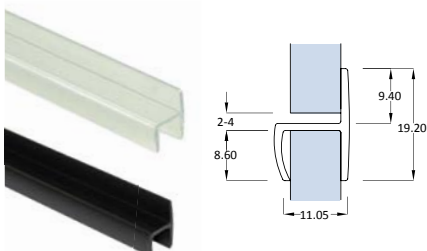

1401

Profile "h"

	⊙	L [m]	⊙	
1401.10.25	10	2,50	162 gr	PVC+UV

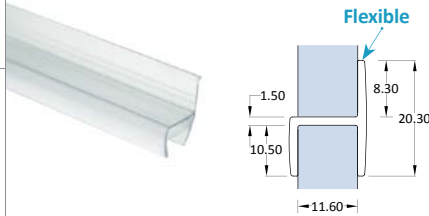

1403

Profile with Flexible Stop

	⊙	L [m]	⊙	
1403.25	10	2,50	220 gr	PVC+UV
1403.30	10	3,00	220 gr	PVC+UV

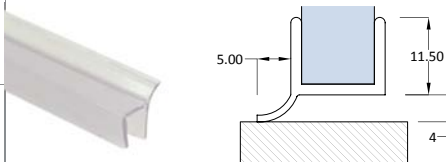

1404/1402

Profile for Showers

	⊙	L [m]	⊙	
1404.08.25	8	2,50	350 gr	PVC+UV
1404.10.25	10	2,50	290 gr	PVC+UV
1404.10.30	10	3,00	350 gr	PVC+UV
1402.08.25	8	2,50	290 gr	PVC+UV
1402.10.25	10	2,50	335 gr	PVC+UV
1402.10.30	10	3,00	350 gr	PVC+UV

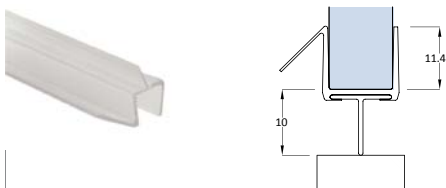

1413/1423

Profile with Magnet

	⊙	L [m]	⊙	
1423.06.20	6	2,00	380 gr	PVC+UV
1413.10.22	10	2,20	420 gr	PVC+UV

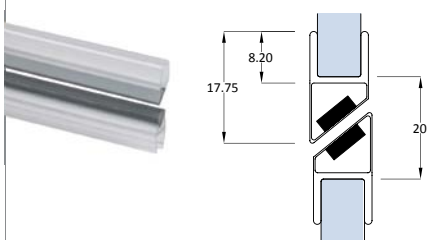

1408

Angle 90° Profile

	⊙	L [m]	⊙	
1408.10.25	10	2,50	315 gr	POL/TE

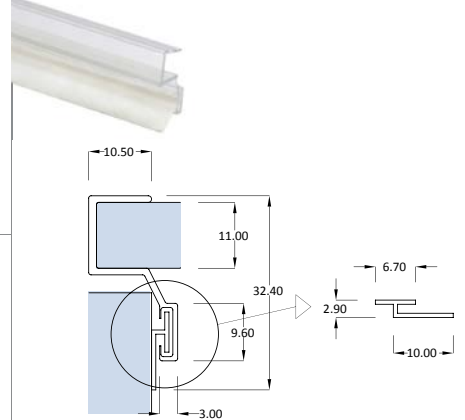

1409

Profile with T-Shape Flexible

	⊙	L [m]	⊙	
1409.08.25	8	2,50	260 gr	PVC+UV
1409.08.30	8	3,00	310 gr	PVC+UV
1409.10.25	10	2,50	260 gr	PVC+UV
1409.10.30	10	3,00	310 gr	PVC+UV
1409.12.25	12	2,50	260 gr	PVC+UV
1409.12.30	12	3,00	310 gr	PVC+UV

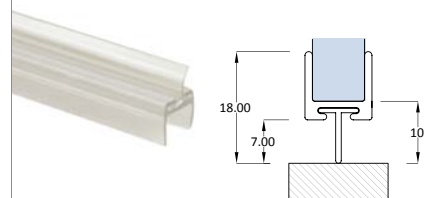

1405/1445

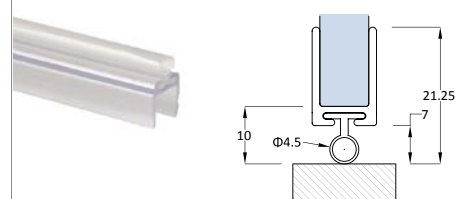

Profile Bubble

	⊙	L [m]	⊙	
1405.08.25	8	2,50	240 gr	PVC+UV
1405.08.30	8	3,00	290 gr	PVC+UV
1405.10.25	10	2,50	240 gr	PVC+UV
1405.10.30	10	3,00	290 gr	PVC+UV
1405.12.30	12	3,00	290 gr	PVC+UV
1445.10.25	10	2,50	240 gr	POL/TE
1445.10.30	10	3,00	290 gr	POL/TE



1412/1443

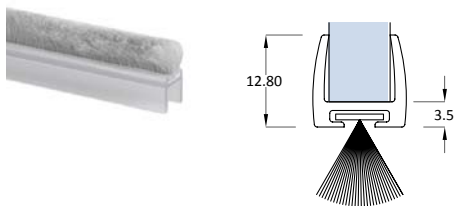

Profile with Brush

		L [m]		
1412.08.12.25	8	2,50	155 gr	PVC+UV
1412.10.08.25	10	2,50	155 gr	PVC+UV
1412.10.08.30	10	3,00	210 gr	PVC+UV
1412.10.08.35	10	3,50	245 gr	PVC+UV
1412.10.12.25	10	2,50	155 gr	PVC+UV
1412.10.12.30	10	3,00	210 gr	PVC+UV
1412.10.12.35	10	3,50	245 gr	PVC+UV
1412.10.18.25	10	2,50	155 gr	PVC+UV
1412.10.18.30	10	3,00	210 gr	PVC+UV
1412.12.08.30	12	3,00	210 gr	PVC+UV
1412.12.08.35	12	3,50	245 gr	PVC+UV
1412.12.12.30	12	3,00	210 gr	PVC+UV
1412.12.12.35	12	3,50	245 gr	PVC+UV
1412.12.18.30	12	3,00	210 gr	PVC+UV
1412.12.18.35	12	3,50	245 gr	PVC+UV
1443.10.08.25	10	2,50	155 gr	POL/TE
1443.10.08.30	10	3,00	210 gr	POL/TE
1443.10.12.25	10	2,50	210 gr	POL/TE
1443.10.12.30	10	3,00	210 gr	POL/TE
1443.10.18.25	10	2,50	155 gr	POL/TE
1443.10.18.30	10	3,00	210 gr	POL/TE



1415/1441

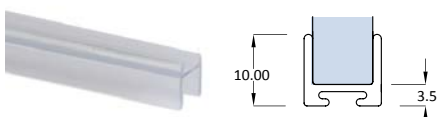

Profile "Π"

		L [m]		
1415.08.25	8	2,50	180 gr	PVC+UV
1415.08.30	8	3,00	220 gr	PVC+UV
1415.10.25	10	2,50	180 gr	PVC+UV
1415.10.30	10	3,00	220 gr	PVC+UV
1415.10.35	10	3,50	255 gr	PVC+UV
1415.12.25	12	2,50	180 gr	PVC+UV
1415.12.30	12	3,00	220 gr	PVC+UV
1415.12.35	12	3,50	255 gr	PVC+UV
1441.10.25	10	2,50	180 gr	POL/TE
1441.10.30	10	3,00	220 gr	POL/TE



1421

Profile Double Flexible Stop

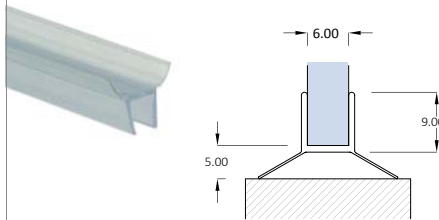

		L [m]		
1421.06.20	6	2,00	120 gr	PVC+UV
1421.06.22	6	2,20	120 gr	PVC+UV

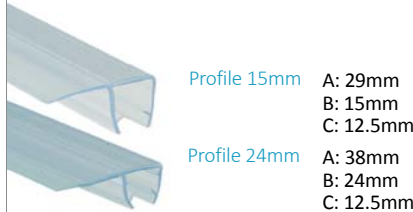

1422

Profile Flexible Angle, 15mm / 24mm PVC+UV



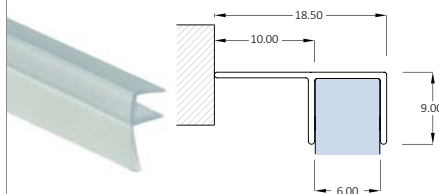

		L [m]		
1422.06.20	6	2,00	132 gr	PVC+UV
1422.06.22	6	2,20	132 gr	PVC+UV
1422.10.15.25	8-10	2,50	220 gr	PVC+UV
1422.10.24.25	8-10	2,50	220 gr	PVC+UV



1435

Profile Large Bubble

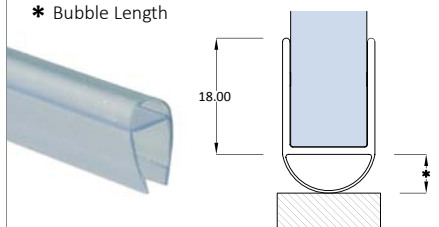

		L [m]	*		
1435.10.06.25	10	2,50	6	270 gr	PVC+UV
1435.10.07.25	10	2,50	7	270 gr	PVC+UV
1435.10.08.25	10	2,50	8	270 gr	PVC+UV

* Bubble Length



1442/1438/1436

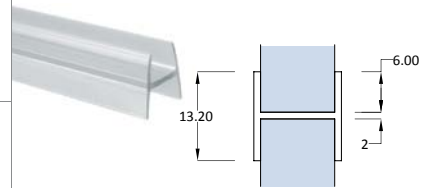

Profile "H"

		L [m]		
1442.10.25	10	2,50	145 gr	PVC+UV
1442.10.30	10	3,00	170 gr	PVC+UV
1442.11.30	11.30	3,00	175 gr	PVC+UV
1436	10	2,50	145 gr	POL/TE
1438	10	3,00	170 gr	POL/TE



1444.2010.10



Curved Weatherproofing profile

		L [m]		
1444.2010.10	10	1,00	189 gr	POL/TE



1446.10.30

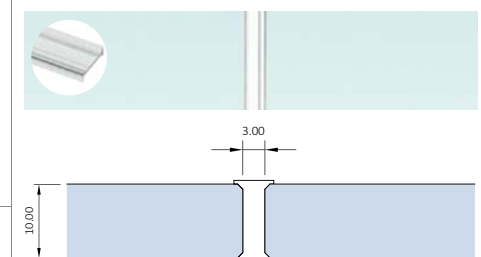

Weatherproofing profile

		L [m]		
1446.10.30	10	3,00	88 gr	POL/TE



1406

Profile Bubble Φ8 Transparent

		L [m]		
1406.10.30	10	3,00	85 gr	POL/TE

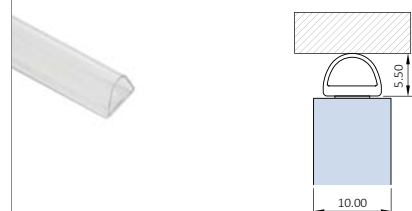

Dimensions mm



bracket- pivot

BRACKET - PIVOT

1003

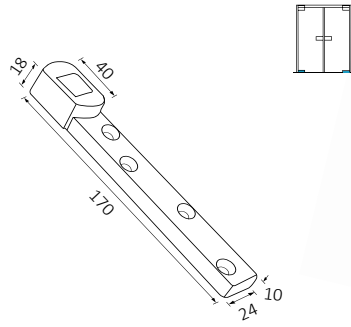

Bracket AL-R, Galvanized Steel

● 342 gr | Finishing .31

FRP75-17

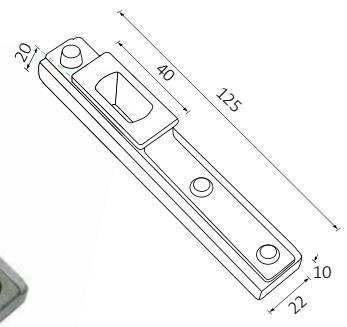

Lower Bracket FRP75 SF, Stainless Steel

● 190 gr

1004

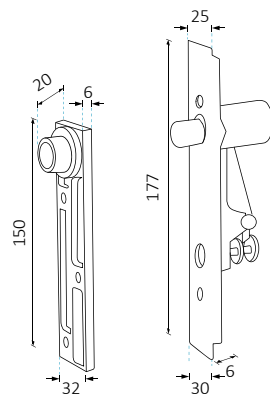

Pivot AL-R ZYNC ALLOY ● 450 gr

FN200-17

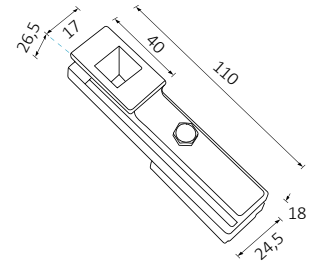

Lower Bracket FN200, Stainless Steel

● 356 gr

1005

1006

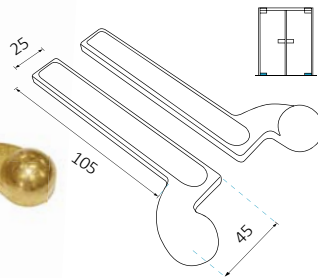

1005 Bracket Left Casted Brass ● 306 gr

1006 Bracket Right Casted Brass ● 296 gr

PR100-17

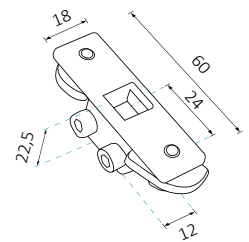

Lower Bracket PR100 SF, Stainless Steel

● 80 gr

1007

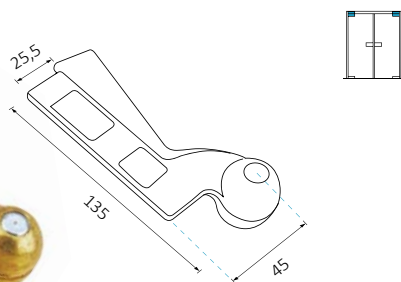

Pivot Left/Right

● 459 gr | Finishing Casted Brass

PR200-17

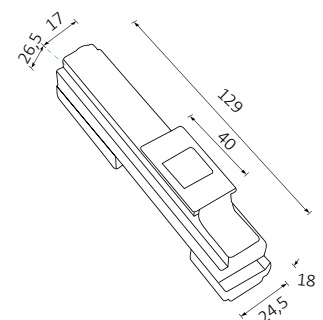

Lower Bracket PR200 SF, Stainless Steel

1130.10 1130.15 1130.20

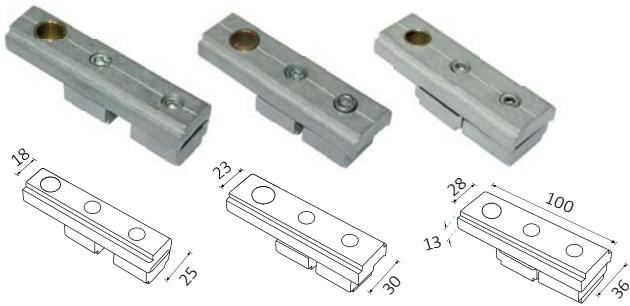

Upper pivot Aluminum

● 120, 144, 174 gr | Finishing .00

1130.HD.12 1130.HD.15 1130.HD.20

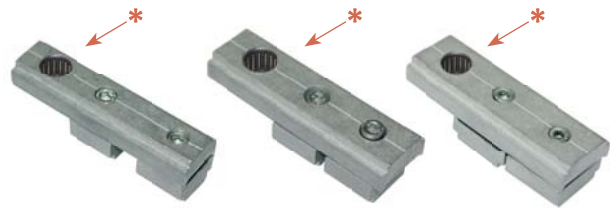

Heavy Duty Upper pivot Aluminum with embedded bearing *

● 120, 144, 174 gr | Finishing .00

1120.10 1120.15 1120.20

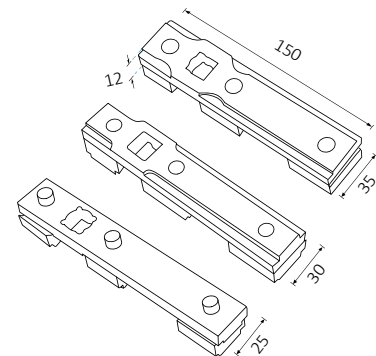

Lower Bracket Galvanized Steel

● 286, 462, 536 gr | Finishing .31

1230.10 1230.15 1230.20



Upper pivot Aluminum

Finishing .00

1230.HD.12 1230.HD.15 1230.HD.20

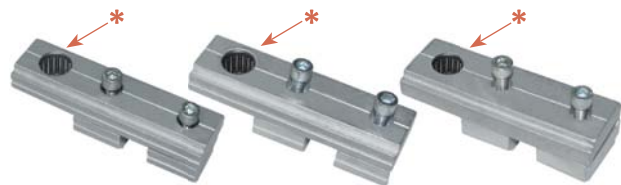

Heavy Duty Upper pivot Aluminum with embedded bearing *

Finishing .00

1220.10 1220.15 1220.20

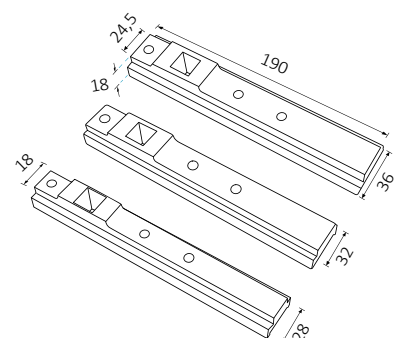

Lower Bracket Stainless Steel

● 362, 420, 458 gr



cylinders

2200



Half Cylinder
111 gr

2201



Security Half Cylinder
185 gr

2202



Cylinder 54 mm
178 gr

2203



Security Cylinder 60 mm
230 gr

2204



Cylinder with Knob
200 gr

2209.19



Half Cylinder with Knob
125 gr

cylinder combinations with same key

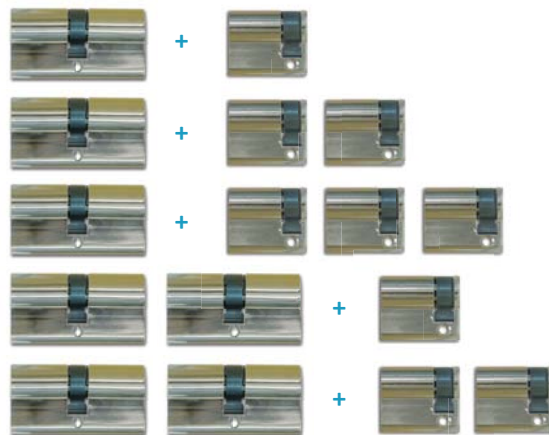

Simple key
5 pins



Safety key
5 pins



2210	2220
2211	2221
2212	2222
2213	2223
2214	2224

Dimensions mm

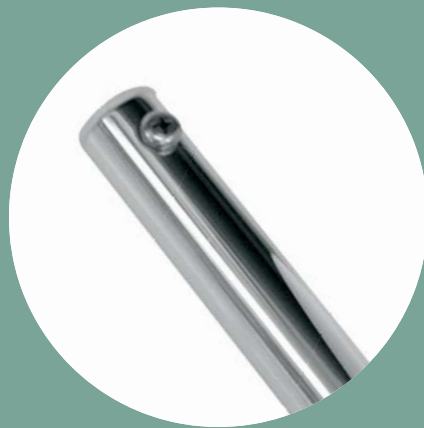

shower supports

SHOWER SUPPORTS

1709



Profile 46 x 21,5 mm
Finishing .25

1713.S



Side Cup for profile 1709
Trasparent Plastic
10 gr

1714.S



Profile 90° for profile 1709
PLastic Chrome Plated
22 gr

1710



Profile 60 x 27 mm
Finishing .25

1713.B



Side Cup for profile 1710
Trasparent Plastic
17 gr

1714.B



Profile 90° for profile 1710
PLastic Chrome Plated
34 gr



1711



Roller for 1709 & 1710
20 gr

1712



Stopper Plastic Rubber
1 gr

1715



Rubber Joint for 1709 & 1710

197

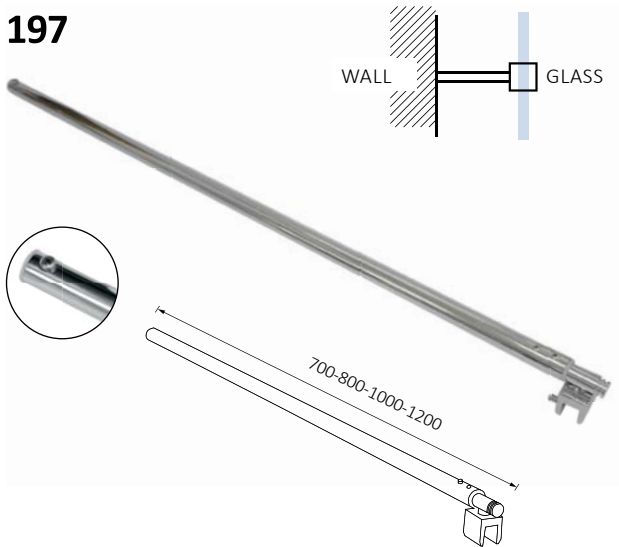

Bathroom Rod G-W Straight

8-10mm 580 gr | Finishing .09

198

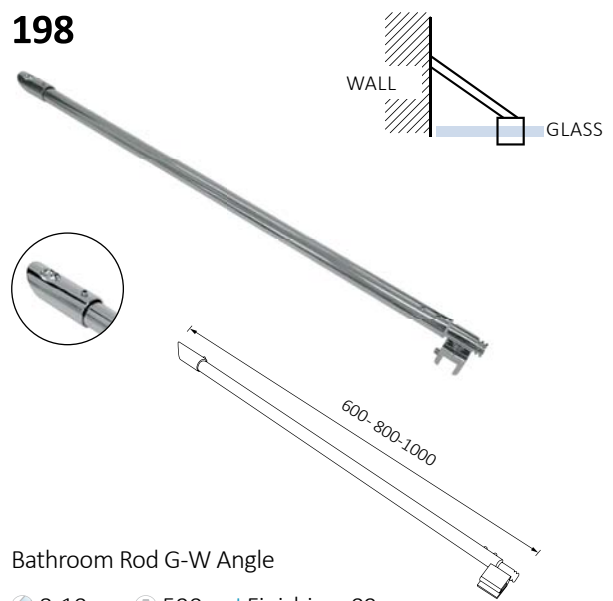

Bathroom Rod G-W Angle

8-10mm 590 gr | Finishing .09

199

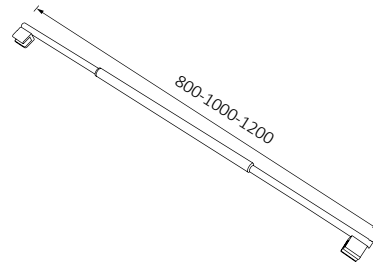
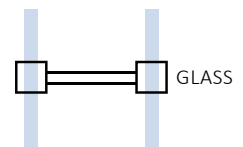
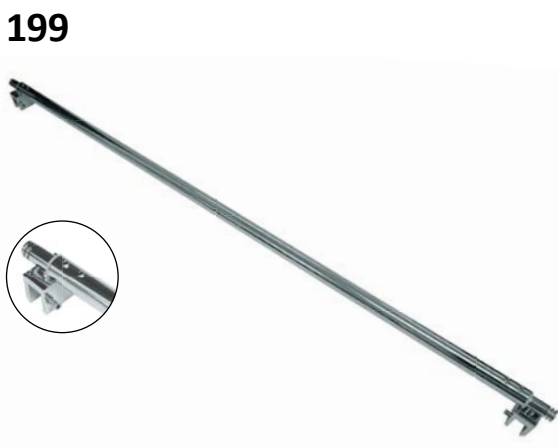

Bathroom Rod G-G

8-10mm 1180 gr | Finishing .09

1692 [STAINLESS STEEL]

CODE	Ø	L
1692.10	8-12	2,50 m
1692.16	14-16	2,50 m
1692.20	18-20	2,50 m

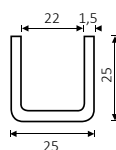
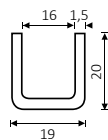
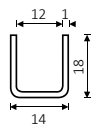

Stainless steel Bar U, Bar 2,5m | Finishing .13 .14

1692 [ALUMINUM]

CODE	Ø	L
1692.10.60	10	6,00 m
1692.16.60	14-16	6,00 m

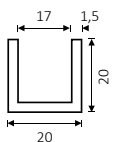
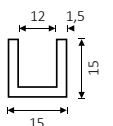

Aluminum Bar U, Bar 6m | Finishing .25

SHOWER SUPPORTS

341.160.13

Upper / Bottom Hinge Stainless Steel

840 gr | Finishing .13

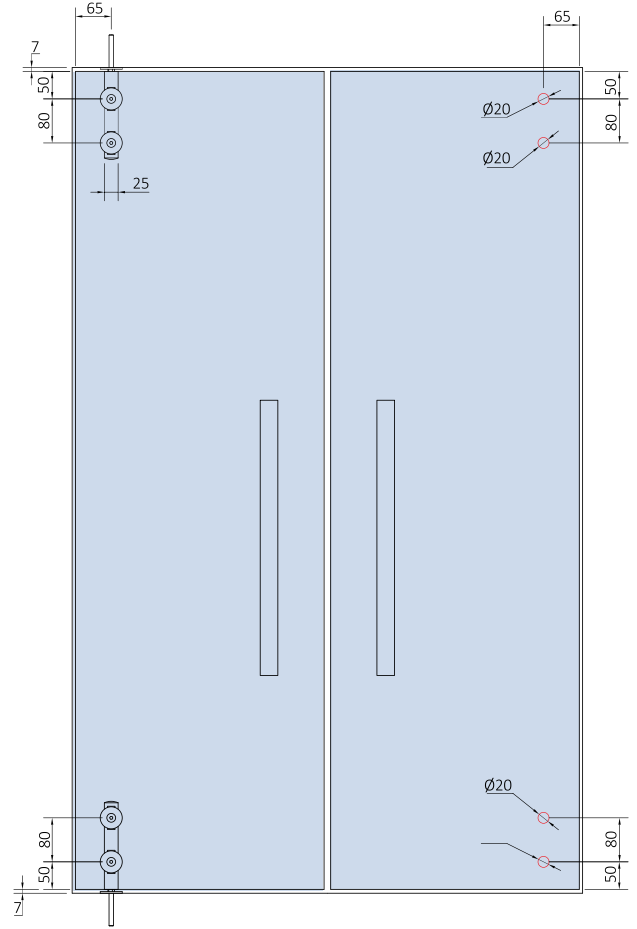

!Suitable

FOR SHOWER DOOR APPLICATION

ANGF1001.13

Set Hinged Door

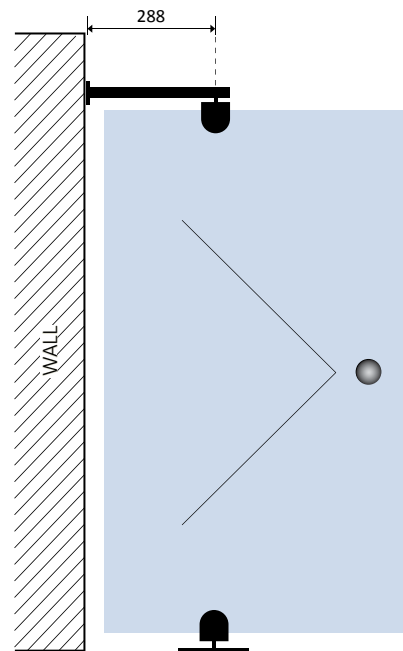

!Suitable

FOR SHOWER DOOR APPLICATION

Dimensions mm

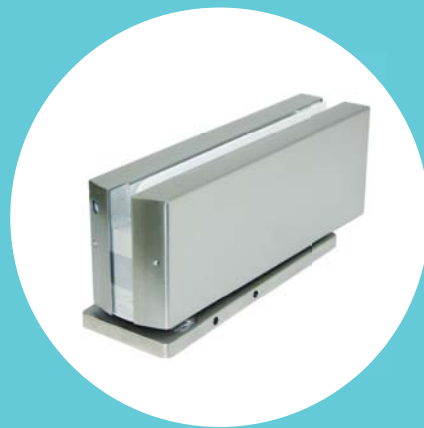

floor springs

NS100H.13

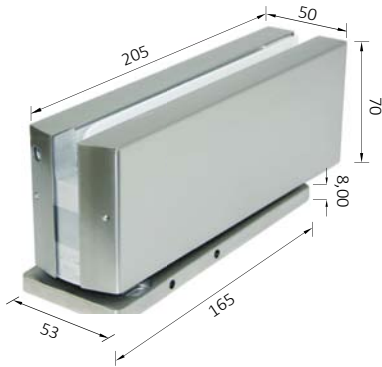

Hydraulic Hinge with Return NOSCAVO®

- 10-12mm ● 2704 gr
- Cover Finishing .13 .14
- Stainless steel

FOR FURTHER TECHNICAL SPECIFICATIONS AND INFORMATION ABOUT THE PRODUCT PLEASE REFER TO THE MANUFACTURER TECHNICAL SHEET NOSCAVO®

2000

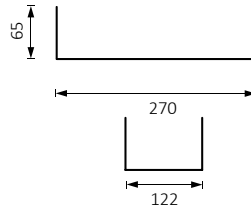

Floor Spring INAL®
Maximum Door Dimension:
1,00m x 2,35m
Aluminum Cover

- 5500 gr

2020

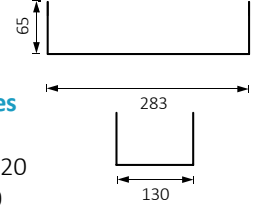

Available in 3 types

- Light: Code 2006
- Medium: Code 2020
- Heavy: Code 2040
- Available also Heavy Duty [until 200 kgr]

Floor Spring SPEEDY M25
Maximum Door Dimension:
1,00m x 2,50m
Aluminum & Stainless steel Cover

- 6625 gr

2022

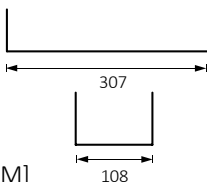

Floor Spring INAL® [M]
Maximum Door Dimension:
1,00m x 2,50m
Stainless steel Cover

- 6000 gr

2028

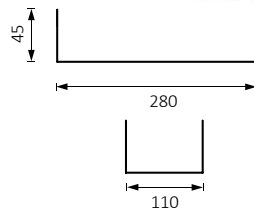

Floor Spring SPEEDY M68
Maximum Door Dimension:
0,95m x 2,20m
Stainless steel Cover

- 6600 gr

2071.13

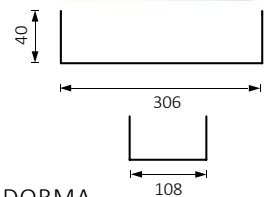

Floor Spring DORMA
Maximum Door Dimension:
0,95m x 2,30m
Stainless steel Cover

- 5100 gr



various

VARIOUS

1300

Profile for Sliding Door 5 mm

1300.3521

Upper Sliding profile for 5mm
Bar 5m | Finishing .01



1300.3522

Middle Sliding profile for 5mm
Bar 5m | Finishing .01



1300.3523

Lower Sliding profile for 5mm
Bar 5m | Finishing .01



Suitable for showcases

1302



Suitable for profile
1300.3522

Roller for Sliding Door 5 mm

16 gr

1738



Plastic Mounting plate

Available from 1mm to 6mm & 8mm

1733



Antipanic Bar for Glass Door

1627

CODE	Weight	CODE	Weight
1627.50.01	52 gr	1627.50.14	152 gr
1627.60.01	80 gr	1627.60.14	212 gr
1627.70.01	128 gr	1627.80.14	382 gr
1627.100.01	220 gr	1627.100.14	612 gr

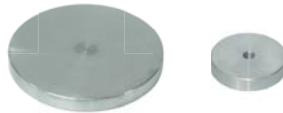

Rings Stainless Steel, Aluminum

1505



Port-Hole Stainless steel
Glass Cutting Ø170

949 gr | Finishing .13

1729



Magnetic Door Stopper

160 gr | Finishing .09

DECO



Decorative Frame Profile L: 2,55m

5mm | Finishing .00 .01 .02 .21WH .33 .42



DECO1020.00

DECO1020.01

DECO1020.02

DECO1020.21WH

DECO1020.33

DECO1020.42

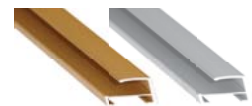

GLASS ACCESSORIES



ALSO DOWNLOAD OUR PRODUCT CATALOGUES

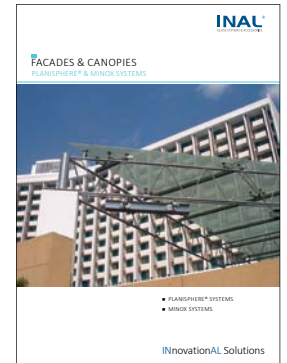
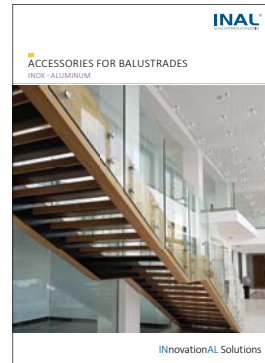

INnovationAL Solutions